

# ***X4***

## ***AC Drive User's Manual***



**TB Wood's Incorporated**  
Chambersburg, PA USA



### **TB Wood's Hassle-Free Warranty**

The driving force at TB Wood's is customer service, including dealing with unforeseen problems without creating new ones. TB Wood's takes the extra step to ensure that **any** problem that occurs with its electronic products is dealt with swiftly and with no hassles to you. The Hassle-Free Warranty removes the "burden of guilt" and promises to quickly replace any failed product.

**TB Wood's Incorporated warrants the X4 Series AC drive to be free of defects in parts or workmanship for a period of three (3) years from the date of manufacture, or two (2) years from the date of installation, whichever comes first. If the TB Wood's X4 Series AC drive fails for any reason, excluding physical abuse or repeated failure, within the warranty period, TB Wood's will promptly replace the product. TB Wood's Incorporated shall not in any event be liable for any incidental or consequential damages, secondary charges, expenses for installing or disconnecting, or losses to persons or property resulting from any failure of the product.**

 is a registered trademark of TB Wood's, Inc. All other product names are trademarks of their respective companies.

Copyright 2007, TB Wood's, Inc. All rights reserved.

## Summary of X4 Parameters

█ = cannot change in Run  
**Bold type** = Level 1 parameter

No.	Parameter Name	Options	Default	User Setting	See Page
<b>001</b>	<b>Model Number</b>	<b>Model Dependent</b>	<b>Read-only</b>		<b>50</b>
002	Software Rev	0.00-99.99	Read-only		50
003	Rated Current	0.0-200.0 A	Read-only		50
005	Serial No. 1	0-65535	Read-only		50
006	Serial No. 2	0-65535	Read-only		50
<b>010</b>	<b>Last Fault</b>	<b>text string</b>	<b>Read-only</b>		<b>50</b>
025	4th Fault	text string	Read-only		50
040	3rd Fault	text string	Read-only		50
055	2nd Fault	text string	Read-only		50
070	1st Fault	text string	Read-only		50
<b>102</b>	<b>Output Freq</b>	<b>0.0-400.0 Hz</b>	<b>Read-only</b>		<b>51</b>
<b>103</b>	<b>Output Voltage</b>	<b>0-600 V</b>	<b>Read-only</b>		<b>51</b>
<b>104</b>	<b>Output Current</b>	<b>0.0-200.0 A</b>	<b>Read-only</b>		<b>51</b>
<b>105</b>	<b>Drive Load</b>	<b>-200.0-200.0%</b>	<b>Read-only</b>		<b>51</b>
<b>106</b>	<b>Load Torque</b>	<b>-200.0-200.0%</b>	<b>Read-only</b>		<b>51</b>
<b>107</b>	<b>Drive Temp</b>	<b>-20.0-200.0 °C</b>	<b>Read-only</b>		<b>51</b>
108	Total Run Time	0.0-6553.5 h	Read-only		51
109	Power On Hours	0-65535 h	Read-only		51
110	Stator Freq	0.0-400.0 Hz	Read-only		51
<b>111</b>	<b>DC Bus Voltage</b>	<b>0 - 1000 Vdc</b>	<b>Read-only</b>		<b>51</b>
115	Drive Power Out	0.0-200.0%	Read-only		51
<b>201</b>	<b>Input Mode</b>	<b>text string</b>	<b>Local Only</b>		<b>52</b>
<b>202</b>	<b>Rev Enable</b>	<b>text string</b>	<b>Forward</b>		<b>52</b>
203	Stop Key Remote	text string	Coast		52
204	Ref Select	text string	Vin1		53
205	Vin1 Config	text string	0-10V		53
206	Vin1 Offset	0.0% to 100.0 %	0.00%		53
207	Vin1 Span	10.0% to 200.0%	100.00%		54
208	Cin Config	text string	0-20mA 50		54
209	Cin Offset	0.0% to 100.0%	0.0%		54
210	Cin Span	10.0% to 200.0%	100.0%		54
211	Vin2 Config	text string	0-10V		54
212	Vin2 Offset	0.0% to 100.0 %	0.00%		54
213	Vin2 Span	10.0% to 200.0%	100.00%		54
214	Vin1 Filter Time	0 to 1000 ms	20 ms		54
215	Cin Filter Time	0 to 1000 ms	20 ms		55
216	Vin2 Filter Time	0 to 1000 ms	20 ms		55
217	Trim Ref Enable	text string	0		55
218	Trim % Factor	-100.0 - 100.0%	0.0%		55
<b>301</b>	<b>Min Frequency</b>	<b>0.0 - Max Freq.</b>	<b>0.0 Hz</b>		<b>55</b>
<b>302</b>	<b>Max Frequency</b>	<b>20.0 - 400.0 Hz</b>	<b>60.0 Hz</b>		<b>55</b>
<b>303</b>	<b>Preset Freq 1</b>	<b>Min Freq-Max Freq</b>	<b>5.0 Hz</b>		<b>55</b>
304	Preset Freq 2	Min Freq-Max Freq	10.0 Hz		55
305	Preset Freq 3	Min Freq-Max Freq	20.0 Hz		55
306	Preset Freq 4	Min Freq-Max Freq	30.0 Hz		55
307	Preset Freq 5	Min Freq-Max Freq	40.0 Hz		55
308	Preset Freq 6	Min Freq-Max Freq	50.0 Hz		55
309	Cut-Off Freq	0.0-5.0 Hz	0.0 Hz		56
401	Ramp Select	text string	ART-DI		56
<b>402</b>	<b>Accel Time 1</b>	<b>0.1-3200.0 sec</b>	<b>5.0 sec</b>		<b>56</b>
<b>403</b>	<b>Decel Time 1</b>	<b>0.1-3200.0 sec</b>	<b>5.0 sec</b>		<b>56</b>

No.	Parameter Name	Options	Default	User Setting	See Page
404	Accel Time 2	0.1-3200.0 sec	3.0 sec		56
405	Decel Time 2	0.1-3200.0 sec	3.0 sec		57
406	DC Inject Config	text string	DC at Stop		57
407	DC Inject Time	0.0-5.0 sec	0.2 sec		57
408	DC Inject Level	0.0% to 100.0%	50.0%		57
409	DC Inj Freq	0.0 to 20.0 Hz	0.0 Hz		57
410	DB Config	text string	Internal		58
414	S Ramp Rounding	1 - 100%	25%		58
490	<b>App Macro</b>	<b>text string</b>	<b>Factory</b>		40
491	<b>Seq Appl</b>	<b>text string</b>	<b>Disabled</b>		40
492	<b>SIO Visible</b>	<b>text string</b>	<b>No</b>		40
501	V/Hz Select	text string	Linear Fixed		59
502	<b>Voltage Boost</b>	<b>0.0-50%</b>	<b>1.0%</b>		59
503	V/Hz Knee Freq	25.0-400.0 Hz	60.0 Hz		59
504	Skip Freq Band	0.2-20.0 Hz	0.2 Hz		60
505	Skip Freq 1	Min Freq-Max Freq	0.0 Hz		60
506	Skip Freq 2	Min Freq-Max Freq	0.0 Hz		60
507	Skip Freq 3	Min Freq-Max Freq	0.0 Hz		60
508	Skip Freq 4	Min Freq-Max Freq	0.0 Hz		60
509	Rated Mtr Volt	100V-690V	Model Dependent		60
510	Rated Mtr FLA	50% - 200% of ND Rating	ND Rating		60
511	Rated Mtr RPM	0-24000 rpm	1750 rpm		60
512	Midpoint Freq	0.0 Hz-V/Hz Knee Freq	60.0 Hz		60
513	Midpoint Volt	0.0-100.0%	100.0%		60
514	Motor RS	0.0-655.35 Ohms	Model Dependent		60
515	Power Factor	0.50-1.00	0.80		60
516	Slip Comp Enable	text string	No		61
517	Single Phase	text string	No		61
519	Find Mtr Data	Not active / Motor RS	Not active		61
520	Filter FStator	1 - 100 ms	8 ms		61
521	Start Field En	Yes / No	No		61
522	Filter Time Slip	10 - 1000 ms	100 ms		61
523	Id Percent	0 - 200%	Read-only		62
524	Iq Percent	0 - 200%	Read-only		62
525	Power Fail Config	text string	CTS No Msg		62
526	UV Ride-Thru En	text string	w/ LVT		62
600	Current Lim Sel	0-6	Fixed Lvl's		63
601	Cur Lim Mtr Fwd	5%-150%	120%		63
602	Cur Lim Mtr Rev	5%-150%	120%		63
603	Cur Lim Reg Fwd	5%-150%	80%		63
604	Cur Lim Reg Rev	5%-150%	80%		63
605	Cur Lim Freq	Min Freq-Max Freq	3.0 Hz		63
606	Ramp Time CL	0.1-3200.0 sec	1.0 sec		63
607	Cur Limit Minimum	0 - 50%	10%		63
608	Restart Number	text string	0		64
609	Restart Delay	0-60 sec	60 sec		64
610	Timed OL Select	text string	Std Ind 60s		64
613	Max Regen Ramp	100 - 1000%	300%		64
700	<b>Vmet Config</b>	<b>text string</b>	<b>Freq Out</b>		65
701	Vmet Span	0.0-200.0%	100.0%		65
702	Imet Config	text string	Drive Load		65
703	Imet Span	0.0-200.0%	100.0%		65
704	Imet Offset	0.0-90.0-%	0.0%		65

No.	Parameter Name	Options	Default	User Setting	See Page
705	Relay 1 Select	text string	Drv Fault		66
706	Relay 2 Select	text string	Drive Run		66
707	DO1 Select	text string	Drv Ready		66
708	DO2 Select	text string	At Speed		66
720	Active Logic	text string	Active High		66
721	D1 Configure	text string	Preset 1		67
722	D2 Configure	text string	Preset 2		67
723	D3 Configure	text string	Preset 3		67
724	D4 Configure	text string	Alt Ramp		67
725	D5 Configure	text string	Fault Reset		67
726	MOL Polarity	text string	NO Operate		67
727	MOL Configure	text string	MOL		68
801	Program Number	0-9999	0		68
802	Start Options	text string	LS Lockout		69
803	PWM Frequency	0.6-16.0 kHz	3.0 kHz		69
804	Display Mode	text string	Std Disply		69
805	Display Units(1)	alphanumeric	RPM:1		70
809	Display Scale	1-65535	1		70
810	Language	text string	English		70
811	Access Code	0-9999	0		70
812	Freq Ref Output	text string	6FS		70
813	Speed Ratio	0.0-200.0%	100.0%		70
814	Display Status	text string	Drive load		71
816	Fly Catch Mode	Sweep FWD / REV / F/R	Sweep FWD		71
850	PI Configure	text string	No PI		71
851	PI Feedback	text string	Vin1		71
852	PI Prop Gain	0-2000	0		72
853	PI Int Gain	0-10000	0		72
854	PI Feed Gain	0-2000	1000		72
855	PI Error 1	0.00-100.00%	Read-only		72
856	PI Error 2	0.00-100.00%	Read-only		72
857	PI High Corr	0.00-100.00%	100.00%		72
858	PI Low Corr	0.00-100.00%	0.00%		72
900	SIO Protocol	text string	RTU N81		72
901	SIO Baud Rate	text string	9600		72
902	Comm Drop #	1-247	1		72
903	SIO Timer	0.0-60.0 sec	1.0 sec		72
904	SIO Cntl Word	text string	0x0000		73
905	Ext Ref Freq1	Min-Max Freq	0.0 Hz		73
906	Ext Ref Freq2	Min-Max Freq	0.0 Hz		73
908	Status Word	text string	Read-only		73
909	DI Status	text string	Read-only		73
910	Vin1 Status	0.00-100.00%	Read-only		74
911	Cin Status	0.00-100.00%	Read-only		74
912	Vin2 Status	0.00-100.00%	Read-only		74
913	Output Status	text string	Read-only		74
914	Vmet Status	0.00-100.00%	Read-only		74
915	Imet Status	0.00-100.00%	Read-only		74
916	Infrared Baud	n/a	9600		74
931	Seq Cntl 1	n/a	00000000000		74
932	Seq Cntl 2	n/a	00000000000		74
933	Seq Cntl 3	n/a	00000000000		74
934	Seq Cntl 4	n/a	00000000000		74

No.	Parameter Name	Options	Default	User Setting	See Page
935	Seq Cntl 5	n/a	00000000000		74
936	Seq Cntl 6	n/a	00000000000		74
937	Seq Cntl 7	n/a	00000000000		74
938	Seq Cntl 8	n/a	00000000000		74
939	Seq Cntl 9	n/a	00000000000		74
951	Seq Count 1	0-65535	0		75
952	Seq Count 2	0-65535	0		75
953	Seq Count 3	0-65535	0		75
954	Seq Count 4	0-65535	0		75
955	Seq Count 5	0-65535	0		75
956	Seq Count 6	0-65535	0		75
957	Seq Count 7	0-65535	0		75
958	Seq Count 8	0-65535	0		75
959	Seq Count 9	0-65535	0		75

---

# TABLE OF CONTENTS

## *X4 User's Manual*

<b>Summary of X4 Parameters</b> .....	<b>iii</b>
<b>Chapter 1: Introduction</b> .....	<b>1</b>
1.1 Product Overview .....	1
1.2 Overview of This Manual .....	1
1.2 User's Manual Publication History .....	2
<b>Chapter 2: Technical Characteristics</b> .....	<b>3</b>
2.1 Interpreting Model Numbers .....	3
2.2 Power and Current Ratings .....	4
2.3 Environmental Specifications .....	5
2.4 Electrical Specifications .....	6
2.5 Control Features Specifications .....	6
2.6 Dimensions and Weights .....	7
<b>Chapter 3: Receiving and Installation</b> .....	<b>12</b>
3.1 Preliminary Inspection .....	12
3.2 Installation Precautions .....	12
3.3 Dissipation Requirements .....	13
3.4 Cover Assembly and Torque Specifications .....	14
3.5 Serial Number Label .....	15
3.6 Conduit Usage .....	15
3.7 Condensation .....	15
<b>Chapter 4: Connections</b> .....	<b>16</b>
4.1 Introduction .....	17
4.2 General Wiring Information .....	17
4.2.1 Wiring Practices .....	17
4.2.2 Considerations for Power Wiring .....	17
4.2.3 Considerations for Control Wiring .....	18
4.3 Input Line Requirements .....	18
4.3.1 Line Voltage .....	18
4.3.2 Line Capacity .....	19
4.3.3 Phase Imbalance .....	19
4.3.4 Single-phase Operation .....	19
4.3.5 Ground Fault Circuit Interrupters .....	20
4.3.6 Motor Lead Length .....	20
4.3.7 Using Output Contactors .....	20
4.4 Terminals Found on the X4 Power Board .....	20
4.4.1 Description of the Terminals .....	20
4.4.2 Typical Power Connections .....	21

4.5	Dynamic Braking .....	23
4.6	Terminals Found on the X4 Control Board .....	25
4.6.1	Description of the Control Terminals .....	25
4.6.2	Typical Connection Diagrams for Digital Inputs .....	28
4.6.3	Typical Connection Diagrams for Analog Inputs .....	29
4.6.4	Typical Connection Diagrams for Analog Outputs .....	29
<b>Chapter 5: Keypad Operation and Programming .....</b>		<b>30</b>
5.1	Introduction .....	30
5.2	Keypad Operation .....	31
5.3	LCD Displays .....	33
5.3.1	Control .....	33
5.3.2	X4 Keypad Status and Warning Messages .....	33
5.3.3	Rights .....	35
5.3.4	Other Data .....	35
5.4	Keypad Display Window .....	35
5.5	Programming .....	36
5.5.1	Accessing Parameters .....	36
5.5.2	Changing the Display Scroll Rate .....	36
5.5.3	Programming Procedure .....	36
5.5.4	Restoring Factory Settings .....	37
5.5.5	Viewing Parameters That Have Changed .....	37
5.5.6	Using Macro Mode .....	37
5.6	Measuring Stator Resistance (RS Measurement) .....	37
5.6.1	Activating Automatic RS Measurement Using the Keypad .....	37
5.6.2	Activating Automatic RS Measurement via Serial Link (Modbus) .....	38
<b>Chapter 6: Using Macro Mode and Getting a Quick Start .....</b>		<b>39</b>
6.1	Entering Macro Mode .....	39
6.2	Description of Parameters Used in Macro Mode .....	40
6.3	Macro Mode Applications and Included Parameters .....	42
6.4	Quick Start .....	48
<b>Chapter 7: X4 Parameters .....</b>		<b>49</b>
7.1	Introduction .....	49
7.2	Level 1 Parameters .....	49
7.3	Description of Parameters .....	50
7.4	Using the X4 Program Sequencer .....	75
7.4.1	Enabling the X4 Program Sequencer .....	75
7.4.2	Controlling the X4 Program Sequencer .....	75
7.4.3	Sequencer State Configuration Overview .....	77
7.4.4	Sequencer Status Indicators .....	80
7.4.5	Sample Sequencer Program .....	80
<b>Chapter 8: Troubleshooting .....</b>		<b>83</b>



---

## Chapter 1: Introduction

### 1.1 Product Overview

Although the X4 AC drive is small in size, it is big on performance. It is an economical yet powerful solution for many industrial applications. It features remote communications capability (using Modbus® protocol), a keypad for easy configuration, and standard NEMA 4X / IP66 and NEMA 12 / IP54 enclosures that eliminate the need for mounting in a separate enclosure.

The X4 product family includes a wide variety of models to suit almost any input voltage requirement. An 'x' in the following table indicates what models are currently available. Refer to Chapter 2 for help in interpreting model numbers.

Horsepower	Input Voltage			
	115 Vac 1 Phase	230 Vac 3 Phase	460 Vac 3 Phase	575 Vac 3 Phase
1	x	x	x	x
2		x	x	x
3		x	x	x
5		x	x	x
7.5		x	x	x
10		x	x	x
15		x	x	x
20		x	x	x
25		x	x	x
30		x	x	x
40			x	x
50			x	x
60			x	x
75			x	x
100			x	x
125			x	x
150			x	x
200			x	x

### 1.2 Overview of This Manual

This manual contains specifications, receiving and installation instructions, configuration, description of operation, and troubleshooting procedures for X4 AC drive devices.

### 1.3 User's Manual Publication History

Date	Form Number	Nature of Change
June 2005	1428	First release
March 2006	1428B	Minor corrections throughout manual. Clarification of technical information and specifications. Added X4 models for Frame Size 2. Reformatted to larger page-size document; separated appendices from manual to be available on the TB Wood's web site ( <a href="http://www.tbwoods.com">www.tbwoods.com</a> ).
August 2006	1428C	Minor corrections and enhancements throughout manual. Added 40 and 50 HP models.
June 2007	1428D	Added 60-200 HP models, new parameters. Minor corrections and reformatting throughout manual.

---

## Chapter 2: Technical Characteristics

### 2.1 Interpreting Model Numbers

The model number of the X4 AC drive appears on the shipping carton label and on the technical data label affixed to the model. The information provided by the model number is shown below:

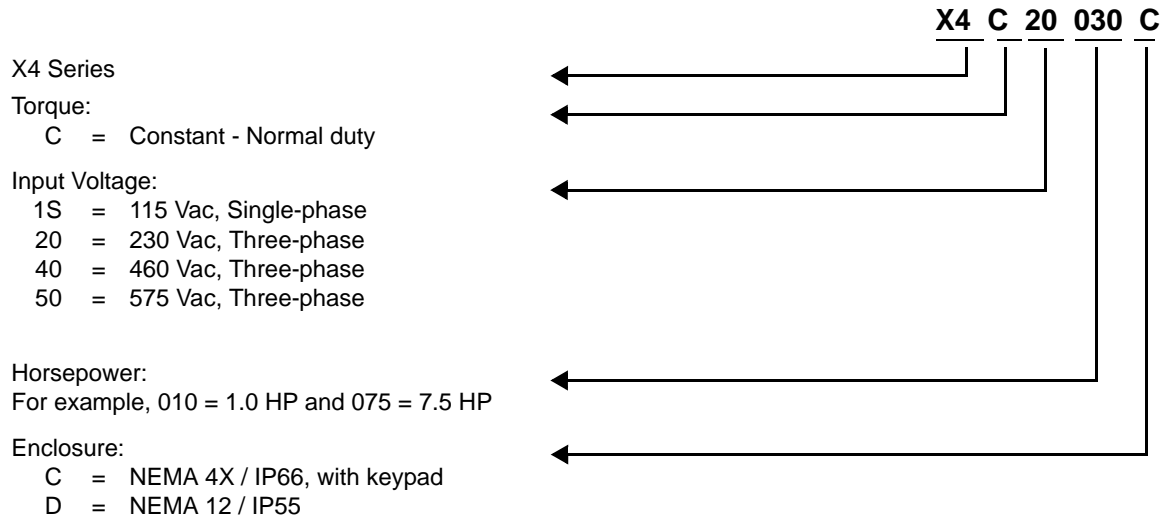

## 2.2 Power and Current Ratings

115 Vac Ratings												
Model number	Normal Duty		Input current (A)		Output current (A)		Heavy Duty		Input current (A)		Output current (A)	
	HP	kW	-	115 Vac	-	230 Vac	HP	kW	-	115 Vac	-	230 Vac
X4C1S010C	1	0.75	-	15	-	4.2	0.5	0.37	-	11	0	2.2

230 Vac Ratings												
Model number	Normal Duty		Input current (A)		Output current (A)		Heavy Duty		Input current (A)		Output current (A)	
	HP	kW	200 Vac	230 Vac	200 Vac	230 Vac	HP	kW	200 Vac	230 Vac	200 Vac	230 Vac
X4C20010C	1	0.75	5.6	4.8	4.8	4.2	0.5	0.37	2.9	2.5	2.5	2.2
X4C20020C	2	1.5	9	7.8	7.8	6.8	1	0.75	5.6	4.8	4.8	4.2
X4C20030C	3	2.2	12.7	11	11	9.6	2	1.5	9	7.8	7.8	6.8
X4C20050C	5	4	20.2	17.5	17.5	15.2	3	2.2	12.7	11	11	9.6
X4C20075C	7.5	5.5	29.2	25.3	25.3	22	5	4	20.2	17.5	17.5	15.2
X4C20100C	10	7.5	37.2	32.2	37.2	28	7.5	5.5	29.2	25.3	25.3	22
X4C20150C	15	11	52.1	46.4	48.3	42	10	7.5	37.2	32.2	37.2	28
X4C20200C	20	15	68.3	57.4	62.1	54	15	11	52.1	46.4	48.3	42
X4C20250C	25	18.5	82.3	73.8	78.2	68	20	15	68.3	57.4	62.1	54
X4C20300C	30	18.5	96	84	92	80	25	18.5	82.3	73.8	78.2	68

NOTE: All 230 Vac models can be operated at single-phase, with 50% derating

460 Vac Ratings												
Model number	Normal Duty		Input current (A)		Output current (A)		Heavy Duty		Input current (A)		Output current (A)	
	HP	kW	380 Vac	460 Vac	380 Vac	460 Vac	HP	kW	380 Vac	460 Vac	380 Vac	460 Vac
X4C40010C	1	0.75	3	2.4	2.4	2.1	0.5	0.37	1.6	1.3	1.3	1.1
X4C40020C	2	1.5	5.2	3.9	3.8	3.4	1	0.75	3	2.4	2.4	2.1
X4C40030C	3	2.2	7.2	5.6	5.1	4.8	2	1.5	5.2	3.9	3.8	3.4
X4C40050C	5	4	12	8.8	8.9	7.6	3	2.2	7.2	5.6	5.1	4.8
X4C40075C	7.5	5.5	15	12.8	12	11	5	4	12	8.8	8.9	7.6
X4C40100C	10	7.5	19.7	16.3	15.6	14	7.5	5.5	15	12.8	12	11
X4C40150C	15	11	30.9	25.8	23	21	10	7.5	19.7	16.3	15.6	14
X4C40200C	20	15	40	33.3	31	27	15	11	30.9	25.8	23	21
X4C40250C	25	18	46.3	40	37	34	20	15	40	33.3	31	27
X4C40300C	30	22	57.5	47.8	43	40	25	18	46.3	40	37	34
X4C40400C	40	30	73.2	62.4	61	52	30	22	57.5	47.8	43	40
X4C40500C	50	37	82	78	71	65	40	30	73.2	62.4	61	52
X4C40600C	60	45	94	80	86	77	50	37	82	78	71	65
X4C40750C	75	55	114	99	105	96	60	45	94	80	86	77
X4C41000C	100	75	149	129	140	124	75	55	114	99	105	96
X4C41250C	125	90	168	156	168	156	100	75	140	124	140	124
X4C41500C	150	110	205	180	205	180	125	90	168	156	168	156
X4C42000C	200	132	240	240	240	240	150	110	205	180	205	180

## 575 Vac Ratings

Model number	Normal Duty		Input current (A)		Output current (A)		Heavy Duty		Input current (A)		Output current (A)	
	HP	kW	-	575 Vac	-	575 Vac	HP	kW	-	575 Vac	-	575 Vac
X4C50010C	1	0.75	-	2.0	-	1.7	0.5	0.37	-	1.2	-	0.9
X4C50020C	2	1.5	-	3.6	-	2.7	1	0.75	-	2.0	-	1.7
X4C50030C	3	2.2	-	5.0	-	3.9	2	1.5	-	3.6	-	2.7
X4C50050C	5	4	-	7.6	-	6.1	3	2.2	-	5.0	-	3.9
X4C50075C	7.5	5.5	-	10.4	-	9.0	5	4	-	7.6	-	6.1
X4C50100C	10	7.5	-	14.1	-	11.0	7.5	5.5	-	10.4	-	9.0
X4C50150C	15	11	-	23	-	17	10	7.5	-	14.1	-	11
X4C50200C	20	15	-	31	-	22	15	11	-	23	-	17
X4C50250C	25	18	-	37	-	27	20	15	-	31	-	22
X4C50300C	30	22	-	39.5	-	32	25	18	-	37	-	27
X4C50400C	40	30	-	49	-	41	30	22	-	39.5	-	32
X4C50500C	50	37	-	58	-	52	40	30	-	49	-	41
X4C50600C	60	45	-	68	-	62	50	37	-	58	-	52
X4C50750C	75	55	-	82	-	77	60	45	-	68	-	62
X4C51000C	100	75	-	107	-	99	75	55	-	82	-	77
X4C51250C	125	90	-	125	-	125	100	75	-	99	-	99
X4C51500C	150	110	-	144	-	144	125	90	-	125	-	125
X4C52000C	200	132	-	192	-	192	150	110	-	144	-	144

## 2.3 Environmental Specifications

Operating temperature	<b>For 2003, 2005, 5005, 2030, 4030, and 5030 models:</b> -10 °C to +35 °C (14 °F to 95 °F) <b>For all other models:</b> -10 °C to +40 °C (14 °F to 104 °F)
Storage temperature	-20 °C to +65 °C (-4 °F to 149 °F)
Humidity	0% to 95% non-condensing
Altitude	1000 m (3300 ft) without derating
Maximum vibration	per EN50178 (1g @ 57-150 Hz)
Acoustic noise	80 dba sound power at 1 m (3 ft), maximum
Cooling	1 to 5 HP models: Natural convection 7.5 to 200.0 HP models: Forced air <b>Note:</b> 575Vac 5 HP model has a fan.

## 2.4 Electrical Specifications

Input voltage	X4C1Sx models: 115 Vac 1 phase, +/- 10% X4C2x models: 200-230 Vac, 3 phase, +/- 15% X4C4x models: 380-460 Vac, 3 phase, +/- 15% X4C5x models: 575Vac, 3 phase, +/-15%			
Line frequency	50 / 60 Hz $\pm$ 2 Hz			
Source kVA (maximum)	10 times the unit rated kVA (see note below)			
DC bus voltage for:	<b>115 Vac models</b>	<b>230 Vac models</b>	<b>460 Vac models</b>	<b>575 Vac models</b>
Overvoltage trip	406 Vdc	406 Vdc	814 Vdc	1017 Vdc
Dynamic brake activation	388 Vdc	388 Vdc	776 Vdc	970 Vdc
Nominal undervoltage (UV) trip	199 Vdc	199 Vdc	397 Vdc	497 Vdc
Control system	V/Hz or SVC Carrier frequency = 1 - 16 kHz, programmable; 8 kHz max. for 125-200 HP models			
Output voltage	0 to 100% of line voltage, three-phase			
Overload capacity	120% of rated normal duty rms current for 60 seconds 150% of rated heavy duty rms current for 60 seconds			
Frequency range	0.1 to 400 Hz			
Frequency stability	0.1 Hz (digital), 0.1% (analog) over 24 hours +/- 10 °C			
Frequency setting	By keypad or by external signal (Speed Pot 0 to 5 Vdc; 0 to 10 Vdc; 0 to 20 mA, or 4 to 20 mA) OR by pulse train up to 100 kHz			

**Note:** Unit Rated kVA = rated Voltage x rated Current x 1.732

## 2.5 Control Features Specifications

(Page 1 of 2)

Vin1 reference input	0-5/10 Vdc, 0/4-20 mAdc (250 $\Omega$ load) 6FS pulse train input, 0-1/10/100 kHz pulse input, inverted function, 0-5-10 bipolar input, broken wire detection. Span and offset adjustment.
Vin2 reference input	0-5/10 Vdc, 0-5-10 bipolar input, inverted function, broken wire detection, span and offset adjustment. Programmable for frequency reference or current limit input.
Cin reference input	0/4-20 mAdc (50 $\Omega$ load), inverted function, span and offset adjustment. Programmable for frequency reference or current limit input.
Reference voltage	10 Vdc (10 mAdc maximum)
Digital inputs - 10	Off=0 to 3 Vdc; On=10 to 32 Vdc (pullup logic), selectable between pullup and pulldown logic
Digital supply voltage	24 Vdc (150 mAdc maximum)
Preset frequencies	3 inputs for seven preset frequencies (selectable)
Digital outputs	2 SPDT relay output - 130 Vac, 1 A/250 Vac, 0.5 A 2 open collector outputs 50 mA per device
Digital pulse train output	Open collector output pulse train proportional to output frequency
Vmet analog output	0 to 10 Vdc (5 mAdc maximum)
Imet analog output	0-20 mAdc output into a 500 $\Omega$ load (maximum)
DC holding / injection braking	At start, stop, by frequency with adjustable current level and time or continuous DC injection by digital input.

(Page 2 of 2)

Current limit	Four quadrant adjustable from 5 to 150%
Speed ramps	Primary and alternate adjustable from 0.1 to 3200.0 seconds
Voltage boost	Fixed boost adjustable from 0 to 50%, or auto boost in Vector mode
Voltage characteristic (V/Hz)	Linear, pump, fan or 2-piece linear
Timed overload	Adjustable inverse time trip (shear pin, 30 sec, 60 sec, 5 min), standard or inverter-duty motors
Protective features	Overcurrent, overvoltage fault, ground fault, short circuit, dynamic brake overload, drive temperature, power wiring fault, drive timed overload, input voltage quality, overvoltage ridethrough
Program Sequence Logic Controller (PSLC)	9-step PLC type functionality that can control speed, direction, and ramps based on time, analog input, digital input, or pulse input.
Serial communications	Modbus Standard: RTU or ASCII

## 2.6 Dimensions and Weights

Table 2-1 lists dimensions and weights for the X4 frame size 0, 1, 2, and 3 models. Dimensions and weights for the X4 frame size 4 and 5 models are shown in Table 2-2 on page 8.

See Figures 2-1, 2-2, 2-3, 2-4, 2-5, and 2-6 on pages 8 - 11 for locations of dimensions. Dimensions A through Q are in inches / millimeters (in/mm). Weight is in pounds / kilograms (lb/kg).

**Table 2-1: Dimensions and Weights for Frame Sizes 0 - 3**

Frame		0			1			2			3		
Voltage		115 Vac	230 Vac	460 Vac	230 Vac	460 Vac	575 Vac	230 Vac	460 Vac	575 Vac	230 Vac	460 Vac	575 Vac
Horsepower		1	1-3		5-7.5	5-10	1-10	10-15	15-30	15-30	20-25	40-50	40-50
Dimensions in (mm) (See X4 diagrams on pages 8 through 10)	A	9.47 (241)			12.01 (306)			17.38 (442)			20.19 (513)		
	B	6.50 (165)			8.72 (221)			10.75 (273)			11.25 (286)		
	C	6.08 (155)			6.51 (166)			7.91 (201)			11.73 (314)		
	D	8.45 (215)			11.03 (280)			16.50 (419)			19.25 (489)		
	E	5.69 (145)			7.88 (200)			9.76 (248)			7.88 (200)		
	F	0.28 (7.11)			0.28 (7.11)			0.41 (10)			0.28 (7.11)		
	G	3.84 (98)			4.05 (103)			4.72 (120)			7.78 (198)		
	H	2.77 (70)			N/A			N/A			N/A		
	J	1.93 (49)			2.31 (59)			2.88 (73)			0.65 (13)		
	K	2.85 (72)			3.94 (100)			4.84 (123)			2.29 (58)		
	L	3.75 (95)			5.56 (1.41)			6.88 (175)			3.95 (100)		
	M	0.88 (22)			0.88 (22)			1.38 (35)			1.69 (44)		
	N	N/A			N/A			1.13 (29)			0.88 (22)		
P	N/A			N/A			N/A			5.60 (142)			
Q	N/A			N/A			N/A			7.24 (184)			
Weight lb (kg)		8.5 (3.85)			14.0 (6.35)			29.5 (13.38)			50.0 (22.68)		

Table 2-2: Dimensions and Weights for Frame Sizes 4-5

Frame	4		5		
Voltage	460 Vac	575 Vac	460 Vac	575 Vac	
Horsepower	60-100	60-100	125-200	125-200	
Dimensions in (mm) (See X4 diagrams on pages 10 - 11)	A	29.35 (745)	29.35 (745)	50.77 (1290)	51.02 (1296)
	B	12.84 (326)	12.84 (326)	16.31 (414)	16.31 (414)
	C	13.80 (351)	13.80 (351)	16.88 (429)	16.88 (429)
	D	28.00 (711)	28.00 (711)	45.77 (1163)	45.77 (1163)
	E	7.88 (200)	7.88 (200)	7.65 (194)	7.65 (194)
	F	0.42 (11)	0.42 (11)	0.42 (11)	0.42 (11)
	G	8.63 (219)	8.63 (219)	12.57 (319)	12.57 (319)
	H	8.26 (210)	8.26 (210)	11.10 (282)	11.10 (282)
	J	0.53 (14)	0.53 (14)	0.20 (5)	0.20 (5)
	K	2.69 (68)	2.69 (68)	2.32 (59)	2.32 (59)
	L	3.94 (100)	3.94 (100)	3.82 (97)	3.82 (97)
	M	2.44 (62)	2.44 (62)	2.94 (75)	2.94 (75)
	N	0.88 (22)	0.88 (22)	0.88 (22)	0.88 (22)
	P	5.19 (132)	5.19 (132)	5.32 (135)	5.32 (135)
	Q	7.35 (187)	7.35 (187)	7.45 (189)	7.45 (189)
	R	10.23 (260)	10.23 (260)	N/A	N/A
S	1.94 (49)	1.94 (49)	1.86 (47)	1.86 (47)	
Weight lb (kg)	95.0 (43.10)		305.0 (138.35)		

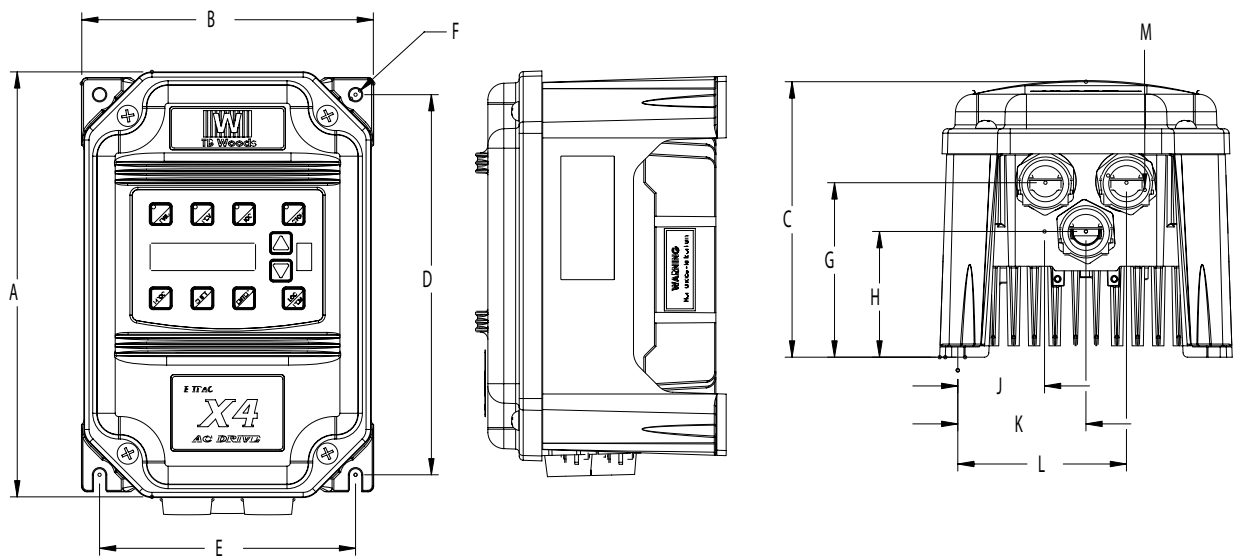

Figure 2-1: X4 Frame Size 0 Models



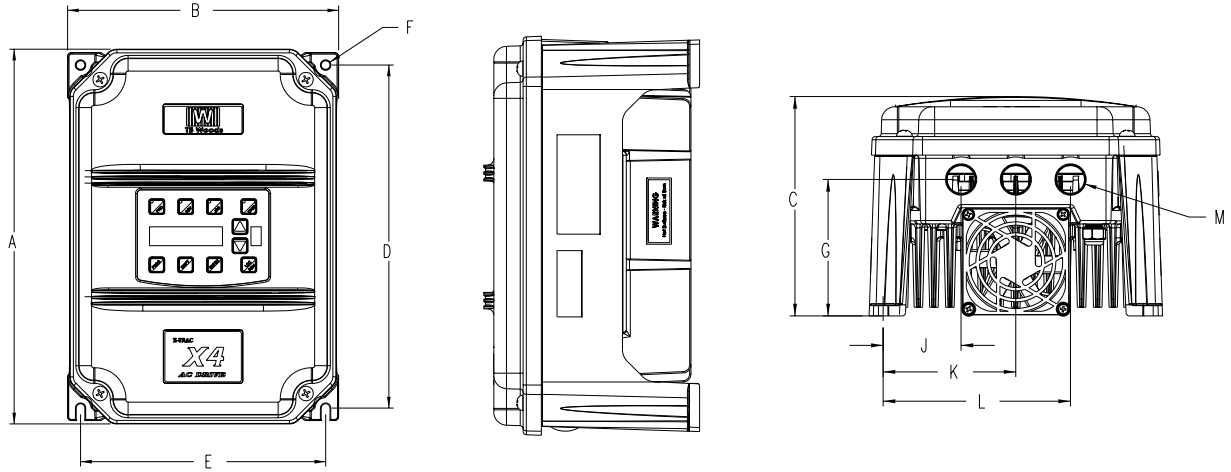

Figure 2-2: X4 Frame Size 1 Models

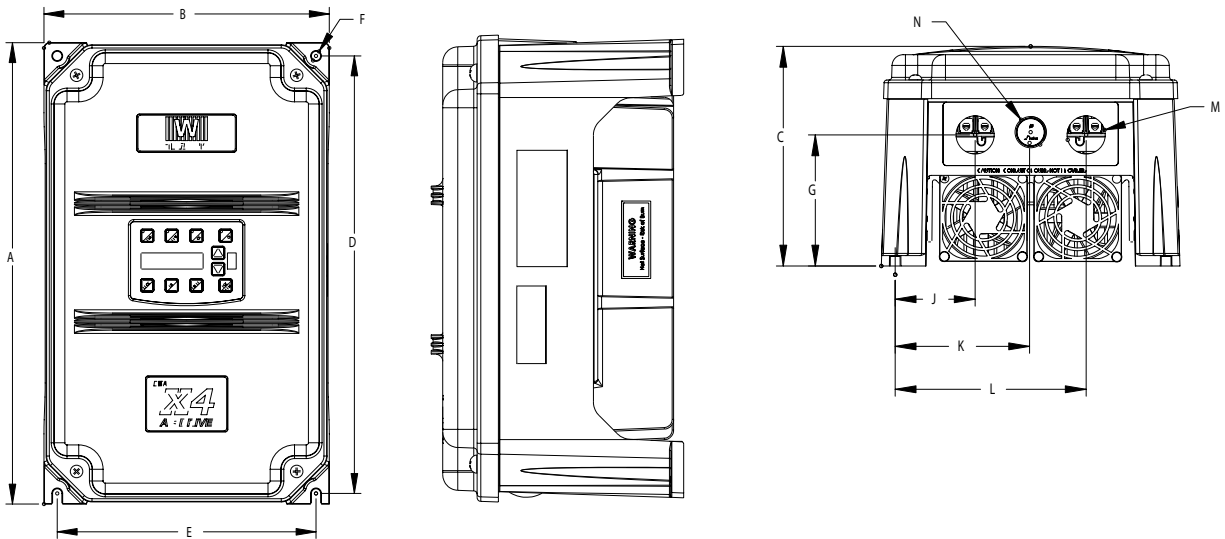

Figure 2-3: X4 Frame Size 2 Models

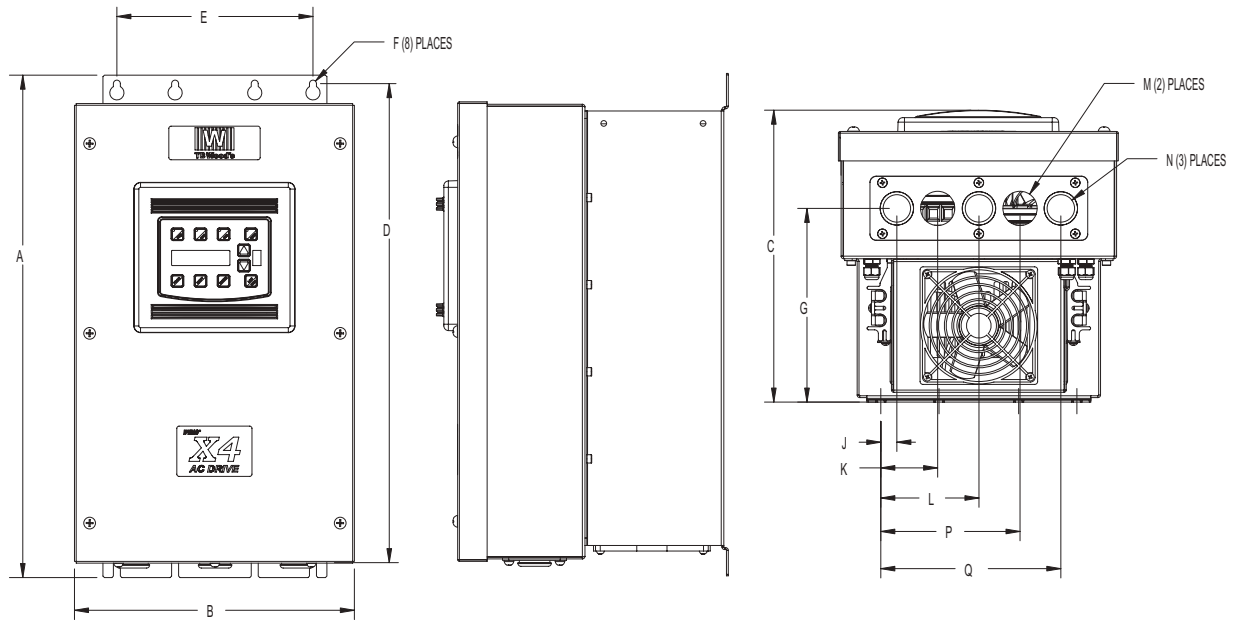

Figure 2-4: X4 Frame Size 3 Models

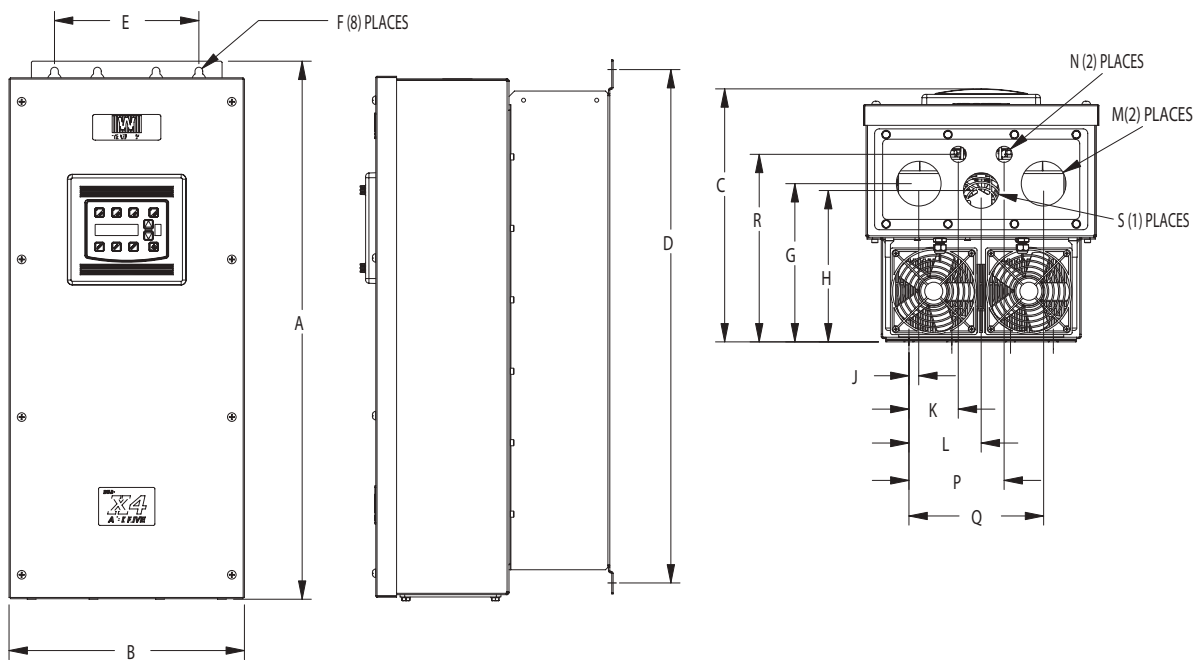

Figure 2-5: X4 Frame Size 4 Models

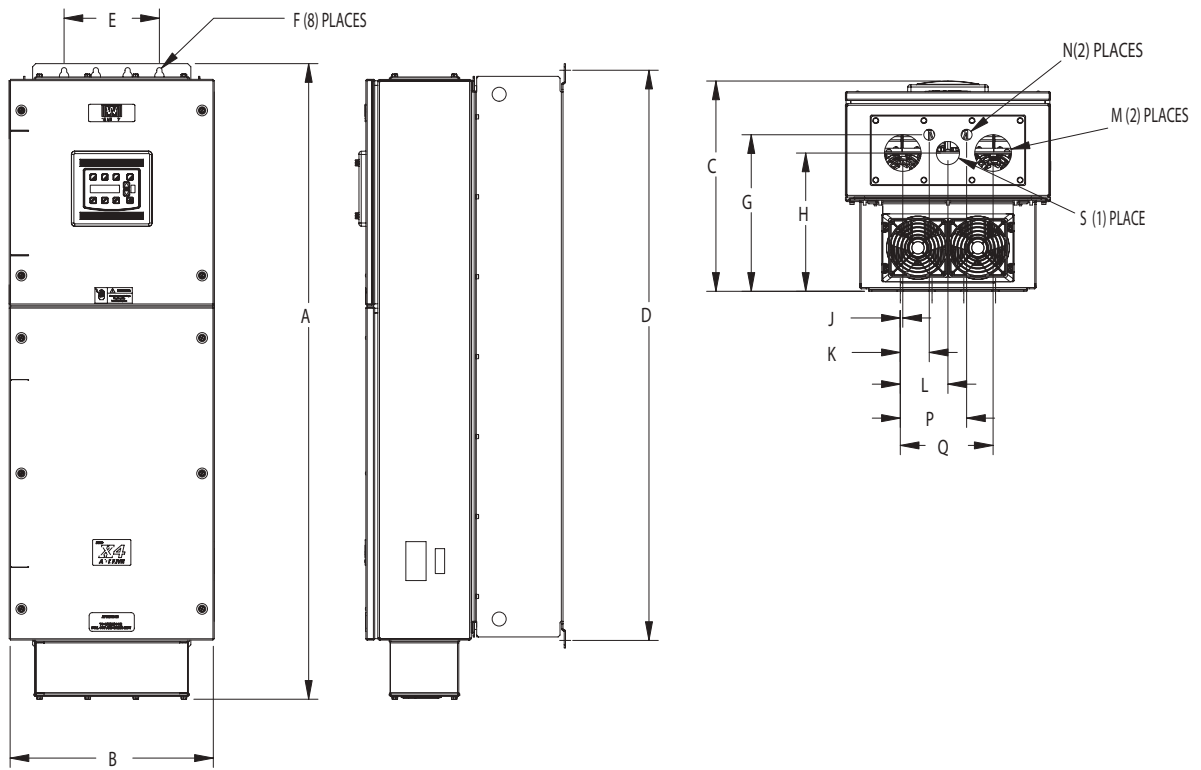

Figure 2-6: X4 Frame Size 5 Models

---

## Chapter 3: Receiving and Installation

### 3.1 Preliminary Inspection

Before storing or installing the X4 AC drive, thoroughly inspect the device for possible shipping damage. Upon receipt:

1. Remove the drive from its package and inspect exterior for shipping damage. If damage is apparent, notify the shipping agent and your sales representative.
2. Remove the cover and inspect the drive for any apparent damage or foreign objects. (See Figure 3-1 on page 14 for locations of cover screws.) Ensure that all mounting hardware and terminal connection hardware is properly seated, securely fastened, and undamaged.
3. Read the technical data label affixed to the drive and ensure that the correct horsepower and input voltage for the application has been purchased.
4. If you will be storing the drive after receipt, place it in its original packaging and store it in a clean, dry place free from direct sunlight or corrosive fumes, where the ambient temperature is not less than -20 °C (-4 °F) or greater than +65 °C (+149 °F).

#### CAUTION

##### **EQUIPMENT DAMAGE HAZARD**

Do not operate or install any drive that appears damaged.

**Failure to follow this instruction can result in injury or equipment damage.**

#### ATTENTION

##### **RISQUE DE DOMMAGES MATÉRIELS**

Ne faites pas fonctionner et n'installez pas tout variateur de vitesse qui semble être endommagé.

**Si cette directive n'est pas respectée, cela peut entraîner des blessures corporelles ou des dommages matériels.**

### 3.2 Installation Precautions

Improper installation of the X4 AC drive will greatly reduce its life. Be sure to observe the following precautions when selecting a mounting location. **Failure to observe these precautions may void the warranty!** See the inside front cover of this manual for more information about the warranty.

- Do not install the drive in a place subjected to high temperature, high humidity, excessive vibration, corrosive gases or liquids, or airborne dust or metallic particles. See Chapter 2 for temperature, humidity, and maximum vibration limits.
- Do not mount the drive near heat-radiating elements or in direct sunlight.
- Mount the drive vertically and do not restrict the air flow to the heat sink fins.
- The drive generates heat. Allow sufficient space around the unit for heat dissipation. See “Dissipation Requirements” on page 13.

### 3.3 Dissipation Requirements

Table 3-1: Dissipation Requirement for X4 Models (Page 1 of 2)

Model	Required Dissipation for Models Entirely Inside an Enclosure at Rated Current, 3KHz Carrier Frequency (Watts)	Required Dissipation When Fins are External to the Enclosure (Watts)
X4C1S010C	47	13
X4C20010C	48	14
X4C20020C	71	17
X4C20030C	92	16
X4C20050C	132	20
X4C20075C	177	23
X4C20100C	263	67
X4C20150C	362	68
X4C20200C	550	97
X4C20250C	653	96
X4C20300C	779	103
X4C40010C	34	13
X4C40020C	46	16
X4C40030C	71	20
X4C40050C	91	21
X4C40075C	114	28
X4C40100C	155	30
X4C40150C	304	77
X4C40200C	393	76
X4C40250C	459	78
X4C40300C	458	77
X4C40400C	695	95
X4C40500C	834	100
X4C40600C	776	130
X4C40750C	988	135
X4C41000C	1638	155
X4C41250C	1656	353
X4C41500C	1891	372
X4C42000C	2302	382

**Table 3-1: Dissipation Requirement for X4 Models** (Page 2 of 2)

Model	Required Dissipation for Models Entirely Inside an Enclosure at Rated Current, 3KHz Carrier Frequency (Watts)	Required Dissipation When Fins are External to the Enclosure (Watts)
X4C50010C	32	15
X4C50020C	50	22
X4C50030C	66	21
X4C50050C	112	33
X4C50075C	159	37
X4C50100C	187	54
X4C50150C	334	124
X4C50200C	431	143
X4C50250C	528	154
X4C50300C	597	155
X4C50400C	742	160
X4C50500C	877	170
X4C50600C	766	200
X4C50750C	913	200
X4C51000C	1542	275
X4C51250C	1988	337
X4C51500C	2282	349
X4C52000C	3043	355

### 3.4 Cover Assembly and Torque Specifications

Figure 3-1 shows the locations of the X4 cover screws. The torque range for the X4 covers is 18-26 in/lbs.



**Figure 3-1: X4 Cover Assembly and Screw Locations**

Torque specifications for control terminals and power terminals are listed in “General Wiring Information” on pages 17 and 18.

### 3.5 Serial Number Label

TB Wood's warrants all AC drives for three years from date of manufacture, or two years from the date of installation, whichever comes first. For a more detailed description of TB Wood's warranty policy, see the inside front cover of this manual, or visit the web site at <http://www.tbwoods.com>. To determine if your drive is within the warranty time frame, find the bar code label or look in the lower left of the technical nameplate. The serial number can be broken down as follows:

**yywwxxxx** = **yy**...year of manufacture

**ww**...week of manufacture

**xxxx**...sequential number drive during that week

### 3.6 Conduit Usage

The X4 drive in the NEMA 4X / IP66 enclosure is rated for 1000 psi washdown from 6 inches. To keep this rating, the use of a sealed conduit is required. The use of a Romex-type conduit will not prevent water entry into the enclosure. If the approved conduit is not used, all warranty claims against water damage will be void.

### 3.7 Condensation

The washdown process of an X4 drive may create a temperature and humidity change in and around the drive. If the unit is mounted in a cool environment and washed down with higher-temperature water, as the drive cools to room temperature, condensation can form inside the drive, especially around the display. To prevent this from happening, avoid using sealed connectors around rubber-coated cables to seal the drive. These do not allow any air transfer and hence create a level of condensation and humidity that exceeds the drive's rating.

---

## Chapter 4: Connections

### DANGER

#### HAZARDOUS VOLTAGE

- Read and understand this manual in its entirety before installing or operating the X4 AC drive. Installation, adjustment, repair, and maintenance of these drives must be performed by qualified personnel.
- Disconnect all power before servicing the drive. **WAIT 5 MINUTES** until the DC bus capacitors discharge.
- **DO NOT** short across DC bus capacitors or touch unshielded components or terminal strip screw connections with voltage present.
- Install all covers before applying power or starting and stopping the drive.
- The user is responsible for conforming to all applicable code requirements with respect to grounding all equipment.
- Many parts in this drive, including printed circuit boards, operate at line voltage. **DO NOT TOUCH.** Use only electrically-insulated tools.

Before servicing the drive.

- Disconnect all power.
- Place a “DO NOT TURN ON” label on the drive disconnect.
- Lock the disconnect in the open position.

**Failure to observe these precautions will cause shock or burn, resulting in severe personal injury or death.**

### DANGER

#### TENSION DANGEREUSE

- Lisez et comprenez ces directives dans leurs intégralité avant d'installer ou de faire fonctionner le variateur de vitesse X4. L'installation, le réglage, les réparations et l'entretien des ces variateurs de vitesse doivent être effectuées par du personnel qualifié.
- Coupez toutes les alimentations avant de travailler sur le variateur de vitesse. **ATTENDEZ CINQ MINUTES** pour que la décharge des condensateurs du bus cc s'effectue.
- NE court-cuitez PAS les condensateurs du bus cc ou ne touchez pas aux composantes non blindées ou aux connexions des vis du bornier si l'appareil est sous tension.
- Installez tous les couvercles avant de mettre le variateur de vitesse sous tension, de le mettre en marche ou de l'arrêter.
- L'utilisateur est responsable de la conformité avec tous les codes électriques en vigueur concernant la mise à la terre de tous les appareils.
- De nombreuses pièces de ce variateur de vitesse, y compris les cartes de circuits imprimés, fonctionnent à la tension du secteur. **N'Y TOUCHEZ PAS.** N'utilisez que des outils dotés d'une isolation électrique.

Avant tout entretien ou réparation sur le variateur de vitesse:

- Coupez toutes les alimentations.
- Placez une étiquette «NE PAS METTRE SOUS TENSION» sur le sectionneur du variateur de vitesse.
- Verrouillez le sectionneur en position ouverte.

**Si ces précautions ne sont pas respectées, cela causera une électrocution ou des brûlures, ce qui entraînera des blessures graves ou la mort.**



## 4.1 Introduction

This chapter provides information on connecting power and control wiring to the X4 AC drive.

## 4.2 General Wiring Information

### 4.2.1 Wiring Practices

When making power and control connections, observe these precautions:

- Never connect input AC power to the motor output terminals T1/U, T2/V, or T3/W. Damage to the drive will result.
- Power wiring to the motor must have the maximum possible separation from all other power wiring. Do not run in the same conduit; this separation reduces the possibility of coupling electrical noise between circuits.
- Cross conduits at right angles whenever power and control wiring cross.
- Good wiring practice also requires separation of control circuit wiring from all power wiring. Since power delivered from the drive contains high frequencies which may cause interference with other equipment, do not run control wires in the same conduit or raceway with power or motor wiring.

### 4.2.2 Considerations for Power Wiring

Power wiring refers to the line and load connections made to terminals L1/R, L2/S, L3/T, and T1/U, T2/V, T3/W respectively. Select power wiring using these guidelines:

- Use only UL-recognized wire.
- Wire voltage rating must be a minimum of 300 V for 230 Vac systems and 600 V (Class 1 wire) for 460 or 575 Vac systems.
- Wire gauge must be selected based on 125% of the continuous input current rating of the drive. Wire gauge must be selected from wire tables for 75 °C insulation rating, and must be of copper construction. The 230 V 7.5 and 15 HP models, and the 460 V 30 HP models require 90 °C wire to meet UL requirements. See Chapter 2 for the continuous output ratings for the drive.
- Grounding must be in accordance with NEC and CEC. If multiple X4 drives are installed near each other, each must be connected to ground. Take care not to form a ground loop.

See Table 4-1 on page 18 for a summary of power terminal wiring specifications.

**Table 4-1: X4 Power Terminal Wiring Specifications**

<b>X4 Size / Models</b>	<b>Specifications</b>
<b>Size 0</b>	12 in-lbs nominal torque <b>or</b> 13 in-lbs maximum torque 12-24 awg wire 5/16" (0.3125") strip length
<b>Size 1</b>	16 in-lbs nominal torque <b>or</b> 18 in-lbs maximum torque 8-18 awg wire 5/16" (0.3125") strip length
<b>Size 2</b>	30 in-lbs nominal torque 6-8 awg wire 3/8" (0.38") strip length
<b>Size 3</b>	35 in-lbs nominal torque 3 awg wire
<b>Size 4</b>	65 in-lbs nominal torque 3/0 awg wire max
<b>Size 5</b>	132 in-lbs nominal torque 250MCM wire max

*Note:* Wire type not specified by the manufacturer. Some types of wire may not fit within the constraints of the conduit entry and bend radius inside the drive.

### 4.2.3 Considerations for Control Wiring

Control wiring refers to the wires connected to the control terminal strip. Select control wiring as follows:

- Shielded wire is recommended to prevent electrical noise interference from causing improper operation or nuisance tripping.
- Use only UL recognized wire.
- Wire voltage rating must be at least 300 V for 230 Vac systems. It must be at least 600 V for 460 or 575 Vac systems.

See Table 4-2 below for a summary of power terminal control wiring specifications.

**Table 4-2: X4 Control Wiring Specifications**

<b>X4 Size / Models</b>	<b>Specifications</b>
<b>All Sizes / Models</b>	4.4 in-lbs maximum torque 12-24 awg wire 9/32" strip length

## 4.3 Input Line Requirements

### 4.3.1 Line Voltage

See "Power and Current Ratings" on page 4 for the allowable fluctuation of AC line voltage for your particular X4 model. A supply voltage above or below the limits given in the table will cause the drive to trip with either an overvoltage or undervoltage fault.

Exercise caution when applying the X4 AC drive on low-line conditions.

For example, an X4 2000 series unit will operate properly on a 208 Vac line, but the maximum output voltage will be limited to 208 Vac. If a motor rated for 230 Vac line voltage is controlled by this drive, higher motor currents and increased heating will result.

Therefore, ensure that the voltage rating of the motor matches the applied line voltage.

### 4.3.2 Line Capacity

If the source of AC power to the X4 AC drive is greater than 10 times the kVA rating shown in Table 4-3 below, an isolation transformer or line reactor is recommended. Consult the factory for assistance in sizing the reactor.

**Table 4-3: X4 Line Capacity (kVA)**

<b>Drive HP</b>	1	2	3	5	7.5	10	15	20	25	30	40	50	60	75	100	125	150	200
<b>Transformer kVA</b>	2	4	5	9	13	18	23	28	36	42	57	70	90	112	150	180	220	250

*Note: X4 AC drive devices are suitable for use on a circuit capable of delivering not more than 65,000 rms symmetrical amperes at 10% above the maximum rated voltage.*

### 4.3.3 Phase Imbalance

Phase voltage imbalance of the input AC source can cause unbalanced currents and excessive heat in the drive's input rectifier diodes and DC bus capacitors. Phase imbalance can also damage motors running directly across the line. The phase imbalance should not exceed 2% of the voltage rating.

#### **⚠ CAUTION**

##### **EQUIPMENT DAMAGE HAZARD**

Never use power-factor correction capacitors on motor terminals T1/U, T2/V, or T3/W of the X4 AC drive. Doing so will damage the semiconductors.

**Failure to follow this instruction can result in injury or equipment damage.**

#### **⚠ ATTENTION**

##### **RISQUE DE DOMMAGES MATÉRIELS**

Ne raccordez jamais de condensateurs de correction du facteur de puissance aux bornes T1/U, T2/V, ou T3/W du moteur du variateur de vitesse X4. Car cela endommagera les semiconducteurs.

**Si cette directive n'est pas respectée, cela peut entraîner des blessures corporelles ou des dommages matériels.**

### 4.3.4 Single-phase Operation

X4 AC drive 230 Vac models ranging from 1 to 5 HP are designed for both three-phase and single-phase input power. If one of these models is operated with single-phase power, use any two line input terminals. The output of the device will always be three-phase.

The safe derating of the X4 series of drives is 50% of the nominal current (HP) rating. Consult the factory with the particular application details for exact derating by model.

### 4.3.5 Ground Fault Circuit Interrupters

X4 drives rated for 115 Vac are **not** designed to operate with ground fault circuit interrupters (GFCI). The GFCI breakers are designed for residential use to protect personnel from stray currents to ground. Most GFCI breakers will shut off at 5 mA of leakage. It is not uncommon for an AC drive to have 30 to 60 mA of leakage.

### 4.3.6 Motor Lead Length

TB Wood's recommends that the total lead length should not exceed the motor manufacturer's guidelines. Line disturbance and noise can be present in motor wiring of any distance. As a rule of thumb, any non-inverter duty motor should have a reactor or filter added when the motor lead length exceeds 150 feet. The carrier frequency for the drive should also be reduced using parameter **803 (PWM Frequency)**.

Nuisance trips can occur due to capacitive current flow to ground. These currents can cause shock to personnel and can create problems within the motor. Care should be taken when working in these areas.

Some applications can have a restricted lead length because of type of wire, motor type, or wiring placement. Consult the factory and the motor manufacturer for additional information.

### 4.3.7 Using Output Contactors

Contactors in the output wiring of an AC drive may be needed as part of the approved safety circuit. Problems can arise if these contactors are opened for the safety circuit and the drive is left in run mode of operation. When the contactor is open, the drive is in a no-load, no-resistance state, but is still trying to supply current to the motor. However, when the contactor closes, the drive sees the motor resistance and instantly demands current. This inrush of current when the contactor closes can fault or cause failure to the drive.

To prevent problems, interlock an auxiliary contact to the drive's Run or Enable circuit to stop the drive when the contactor opens. In this way, the drive will be disabled and no inrush will occur when the contactor is closed again.

## 4.4 Terminals Found on the X4 Power Board

### 4.4.1 Description of the Terminals

Table 4-4 describes the X4 power terminals.

**Table 4-4: Description of X4 Power Terminals**

Terminal	Description
L1/R L2/S L3/T	These terminals are the line connections for input power. (Single-phase 115 and 230 Vac, 1 to 5 HP models connect to any two of these terminals.)
T1/U T2/V T3/W	These terminals are for motor connections.

Note that earth ground is on the terminal strip (see Figure 4-1 below). Dynamic brake (DB) connections are not on the terminal strip, but on "fast on" (spade) connectors for models up to 30 HP,

and on the terminal strip for models 40 HP and larger. See page 23 for specific information about dynamic braking.

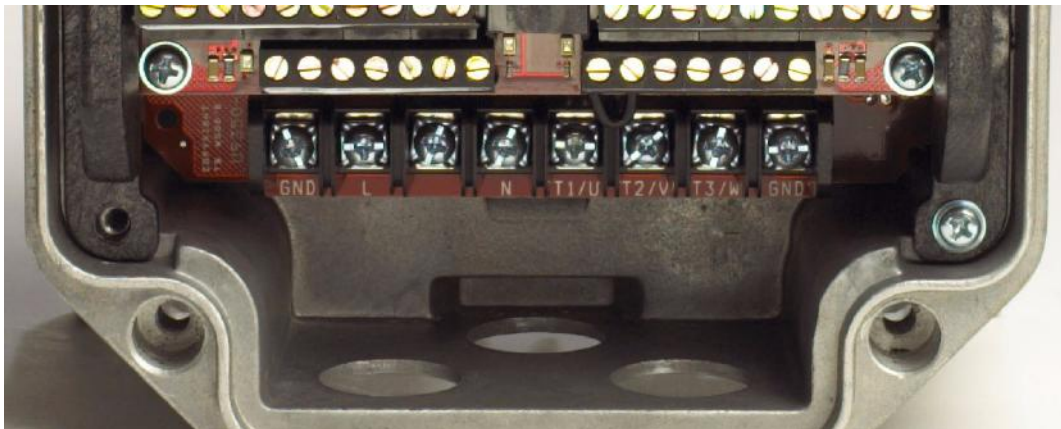
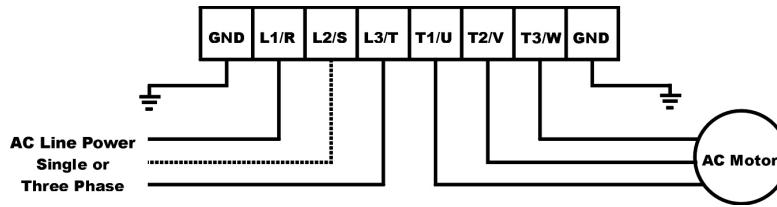

Figure 4-1: X4 Power Terminals



Figure 4-2: Power Terminals on Higher-HP Models

#### 4.4.2 Typical Power Connections

See Section 4.3 starting on page 18 for input line requirements.

Note that when testing for a ground fault, do not short any motor lead (T1/U, T2/V, or T3/W) back to an input phase (L1/R, L2/S, or L3/T).

It is necessary to provide fuses and a disconnect switch for the input AC line in accordance with all applicable electrical codes. The X4 AC drive is able to withstand a 150% overload for 60 seconds for heavy duty rating, and 120% overload for normal duty rating.

The fusing and input protection of the drive must always meet UL, NEC (National Electric Code), and CEC (Canadian Electric Code) requirements. All fuse ratings included in Table 4-5 below are for reference only and do not supersede code requirements. The recommended supplier is Bussman.

**Table 4-5: Fuse Ratings** (Page 1 of 2)

Model Number	Fuse Size 115 Vac JJS/JJN	Fuse Size 208 Vac JJS/JJN	Fuse Size 230 Vac JJS/JJN	Fuse Size 380 Vac JJS	Fuse Size 460 Vac JJS	Fuse Size 575 Vac JJS
X4C1S010C	20	—	—	—	—	—
X4C20010C	—	10	6	—	—	—
X4C20020C	—	15	10	—	—	—
X4C20030C	—	20	15	—	—	—
X4C20050C	—	30	25	—	—	—
X4C20075C	—	40	35	—	—	—
X4C20100C	—	50	40	—	—	—
X4C20150C	—	70	60	—	—	—
X4C20200C	—	90	80	—	—	—
X4C20250C	—	100	90	—	—	—
X4C20300C	—	125	110	—	—	—
X4C40010C	—	—	—	6	6	—
X4C40020C	—	—	—	10	6	—
X4C40030C	—	—	—	10	10	—
X4C40050C	—	—	—	15	15	—
X4C40075C	—	—	—	20	20	—
X4C40100C	—	—	—	25	20	—
X4C40150C	—	—	—	40	35	—
X4C40200C	—	—	—	50	40	—
X4C40250C	—	—	—	60	50	—
X4C40300C	—	—	—	80	60	—
X4C40400C	—	—	—	100	80	—
X4C40500C	—	—	—	110	100	—
X4C40600C	—	—	—	125	100	—
X4C40750C	—	—	—	150	125	—
X4C41000C	—	—	—	200	175	—
X4C41250C	—	—	—	225	200	—
X4C41500C	—	—	—	250	225	—
X4C42000C	—	—	—	300	300	—
X4C50010C	—	—	—	—	—	6
X4C50020C	—	—	—	—	—	6
X4C50030C	—	—	—	—	—	10
X4C50050C	—	—	—	—	—	10
X4C50075C	—	—	—	—	—	15
X4C50100C	—	—	—	—	—	20
X4C50150C	—	—	—	—	—	30
X4C50200C	—	—	—	—	—	40

**Table 4-5: Fuse Ratings** (Page 2 of 2)

Model Number	Fuse Size 115 Vac JJS/JJN	Fuse Size 208 Vac JJS/JJN	Fuse Size 230 Vac JJS/JJN	Fuse Size 380 Vac JJS	Fuse Size 460 Vac JJS	Fuse Size 575 Vac JJS
X4C50250C	—	—	—	—	—	50
X4C50300C	—	—	—	—	—	50
X4C50400C	—	—	—	—	—	70
X4C50500C	—	—	—	—	—	80
X4C50600C	—	—	—	—	—	90
X4C50750C	—	—	—	—	—	110
X4C51000C	—	—	—	—	—	150
X4C51250C	—	—	—	—	—	175
X4C51500C	—	—	—	—	—	200
X4C52000C	—	—	—	—	—	250

## 4.5 Dynamic Braking

The X4 AC drive is supplied with an integrated dynamic braking (DB) resistor, and is designed to have adequate dynamic braking for most applications. In cases where short stopping times or high inertia loads require additional braking capacity, install an external resistor.

**Note:** External braking cannot be added to **Size 0** models. For **Size 4** (60-100 HP) and **Size 5** (125-200 HP) models, additional external dynamic braking requires a kit that provides the connections to the braking transistors. The **XDBKITS4** and **XDBKITS5** kits can be purchased through local distributors.

If an external resistor is used for dynamic braking (not applicable for Size 0 models), **the internal resistor must be disconnected**. Internal DB resistors are connected with fast-on terminals. To install an external resistor, first disconnect the internal DB resistor (or resistors in 460 and 575 Vac models) and properly terminate the wires leading to it. Then connect the external resistor fast-on terminals where the internal resistor had been connected.

Changes to parameter **410 (DB Config)** must be made when using external DB resistors.

Verify with the manufacturer of the selected resistor that the resistor is appropriate for your application. Contact TB Wood's Electronic Application Engineering for further assistance with other possible sizing limitations.

Refer to Table 4-6 on page 24 for information about dynamic braking capacity for each X4 model.

**Table 4-6: X4 Dynamic Braking Capacity (Page 1 of 2)** (\* Note that the asterisked X4 model numbers cannot have external braking added)

Model	KW	Standard Resistance	Standard DB % of Drive	Min. Allowed Res.	Max. Peak Watts	Max. Ext. DB % of Drive
1S010*	.75	125	164%	125	1,223	164%
20010*	.75	125	164%	125	1,223	164%
20020*	1.5	125	82%	125	1,223	82%
20030*	2.2	125	55%	125	1,223	55%
20050	3.7	60	68%	43	3,555	95%
20075	5.5	60	45%	30	5,096	91%
20100	7.5	60	34%	27	5,662	76%
20150	11	60	23%	20	7,644	68%
20200	15	30	34%	10	15,288	102%
20250	18	30	27%	10	15,288	82%
20300	22	30	23%	10	15,288	68%
40010*	.75	500	163%	270	2,253	302%
40020*	1.5	500	82%	270	2,253	151%
40030*	2.2	500	54%	270	2,253	101%
40050	3.7	120	136%	100	6,084	163%
40075	5.5	120	91%	75	8,112	145%
40100	7.5	120	68%	75	8,112	109%
40150	11	120	45%	47	12,944	116%
40200	15	120	34%	47	12,944	87%
40250	18	120	27%	47	12,944	69%
40300	22	120	23%	39	15,600	70%
40400	29.8	60	34%	20	30,420	102%
40500	37.3	60	27%	20	30,420	82%
40600	45	60	23%	15	40,560	91%
40750	55	60	18%	10	60,840	109%
41000	75	60	14%	10	60,840	82%
41250	90	60	11%	10	60,840	65%
41500	110	60	9%	10	60,840	54%
42000	132	60	7%	10	60,840	41%
50010	.75	120	1058%	110	8,607	1154%
50020	1.5	120	529%	110	8,607	577%
50030	2.2	120	353%	110	8,607	385%
50050	3.7	120	212%	110	8,607	231%
50075	5.5	120	141%	91	10,404	186%
50100	7.5	120	106%	91	10,404	139%



**Table 4-6: X4 Dynamic Braking Capacity (Page 2 of 2)** (\* Note that the asterisked X4 model numbers cannot have external braking added)

Model	KW	Standard Resistance	Standard DB % of Drive	Min. Allowed Res.	Max. Peak Watts	Max. Ext. DB % of Drive
50150	11	120	71%	62	15,269	136%
50200	15	120	53%	62	15,269	102%
50250	18	120	42%	62	15,269	82%
50300	22	120	35%	62	15,269	68%
50400	29.8	60	53%	24	39,447	132%
50500	37.3	60	42%	24	39,447	106%
50600	45	60	35%	15	63,115	141%
50750	55	60	28%	15	63,115	113%
51000	75	60	21%	20	63,115	85%
51250	90	60	17%	10	94,672	102%
51500	110	60	14%	10	94,672	85%
52000	132	60	11%	10	94,672	63%

## 4.6 Terminals Found on the X4 Control Board

### 4.6.1 Description of the Control Terminals

Figure 4-3 shows the control terminals found on the I/O board of the X4 AC drive. See page 6 for specifications. Table 4-7 on page 26 describes the control terminals.

The drive's control terminals are referenced to earth ground through a resistor / capacitor network. Use caution when connecting analog signals not referenced to earth ground, especially if the communications port (J3) is being used. The J3 port includes a common reference that can be connected to earth ground through the host PLC or computer.

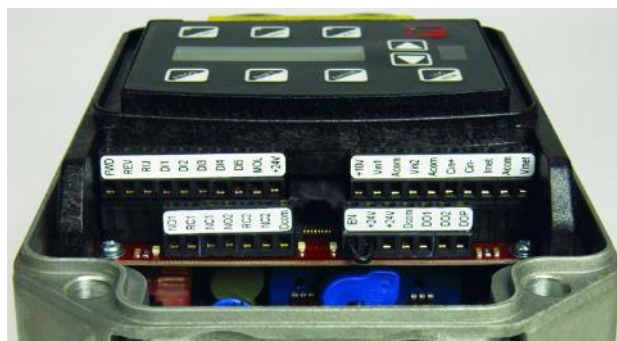

**Figure 4-3: X4 Control Terminals**

**Table 4-7: Description of X4 Control Terminals** (Page 1 of 2)

Terminal	Description
Vmet	Analog output 1, which is a dedicated voltage output. The default signal range is from 0 to 10 Vdc (5 mA maximum). It is proportional to the variable configured by parameter <b>700 (Vmet Config)</b> (see page 65). It may be calibrated while the drive is running via parameter <b>701 (Vmet Span)</b> (see page 65).
Imet	Analog output 2, which is a dedicated current output. The default signal ranges from 0 to 20 mAdc (50 to 500 Ω). It is proportional to the variable configured by parameter <b>702 (Imet Config)</b> (see page 65). It may be calibrated while the drive is running via parameters <b>704 (Imet Offset)</b> and <b>703 (Imet Span)</b> (see page 65).
Vin1	Analog Input 1, which is used to provide speed references. The default input signal is 0 to 10 Vdc (the type of input signal is selected with parameter <b>205 (Vin1 Config)</b> ; see page 53). Parameters <b>206 (Vin1 Offset)</b> and <b>207 (Vin1 Span)</b> may be used to offset the starting value of the range and the size of the range, respectively; see page 53 for more information. If a 0 to 20 mAdc input signal is configured, the burden is 250 Ω. If a 0 to 10 Vdc input signal is configured, the input impedance is 475 kΩ. A potentiometer with a range of 1 to 2 kΩ is suggested for this input.
+10	This terminal is a +10 Vdc source for customer-supplied potentiometers. The maximum load on this supply cannot exceed 10 mAdc.
Cin+ / Cin-	Current Input. The default input signal is 4-20 mA, although this range may be adjusted by using parameters <b>209 (Cin Offset)</b> (which configures an offset for the range) and <b>210 (Cin Span)</b> (to reduce or enlarge the range — for example, setting this parameter to 50% results in a range of 4-12 mA). See page 54 for more information on these parameters. The burden for this terminal is 50 Ω.
Vin2	Voltage Input 2, which is used to provide speed references. The default input signal is 0 to 10 Vdc (the type of input signal is selected with parameter <b>211 (Vin2 Config)</b> ; see page 54). Parameters <b>212 (Vin2 Offset)</b> and <b>213 (Vin2 Span)</b> may be used to offset the starting value of the range and the size of the range, respectively; see page 54 for more information. If a 0 to 20 mAdc input signal is configured, the burden is 250 Ω. If a 0 to 10 Vdc input signal is configured, the input impedance is 475 kΩ. A potentiometer with a range of 1 to 2 kΩ is suggested for this input.
Acom	Common for the Analog Inputs and Outputs. Note that while there are three Acom (common) terminals, they connect to the same electrical point.
+24	A source for positive nominal 24 Vdc voltage, and has a source capacity of 150 mA.
FWD	Forward Direction Selection terminal. This may be connected for two-wire maintained or three-wire momentary operation.
REV	Reverse Direction Selection Terminal. This may be connected for two-wire maintained or three-wire momentary operation.

**Table 4-7: Description of X4 Control Terminals** (Page 2 of 2)

Terminal	Description
R/J	Run/Jog Selector. When this terminal is connected to +24 or common (depending upon Active Logic setting), momentarily connecting either FWD or REV to +24 results in a latched run mode (3-wire operation).
MOL	Motor Overload input terminal. This requires a N/O or N/C contact for operation, referenced to +24 or COM, depending on Active Logic setting.
EN	Enable terminal. A jumper is placed between this terminal and the +24 terminal at the factory. You may replace this with a contact, if desired. The circuit from EN to +24 must be closed for the drive to operate.  Note that unlike all other terminals, this terminal cannot be configured for "pull-down logic." That is, a high input to this terminal is always regarded as true, and <b>must</b> be present for the drive to operate.
Dcom	Digital Common for use with digital inputs and +24 internal power.
DI1-DI5	Digital inputs.  The function of a digital input is configured by the parameter with the same name as the digital input (for example, DI2 is configured by parameter <b>722 (DI2 Configure)</b> ; see page 67.
NC1 NO1 RC1	The first auxiliary relay.  The function of the relay is set by parameter <b>705 (Relay 1 Select)</b> (see page 66); the default setting is for the relay to activate when the motor is at speed.  Terminal NO1 is the normally-open contact, which closes when the relay is activated. Terminal NC1 is the normally-closed contact, which opens when the relay is activated. Terminal RC1 is the common terminal.
NC2 NO2 RC2	The second auxiliary relay.  The function of the relay is set by parameter <b>706 (Relay 2Select)</b> (see page 66); the default setting is for the relay to activate when a fault occurs.  Terminal NO2 is the normally-open contact; it will close when the relay is activated. RC2 is the common terminal.
DO1 DO2	Digital Outputs 1 and 2.  The function of the outputs is set by parameters <b>707 (DO1 Select)</b> and <b>708 (DO2 Select)</b> . The default setting for DO1 is Drive Ready; for DO2 it is At Speed. See page 66.
DOP	Open collector transistor output that supplies a pulse train proportional to speed. The frequency of the output is set by parameter <b>812 (Freq Ref Output)</b> to either 6x or 48x the running frequency. The output has a maximum rating of 28 Vdc and requires a pull-up resistor (4.7 kOhms) if using the drive's internal supply.  Note that if you are using a high-impedance meter to this terminal, the pull-up resistor value may need to change. Please consult the factory for more information.

### 4.6.2 Typical Connection Diagrams for Digital Inputs

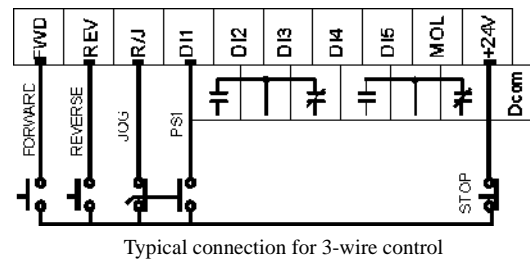
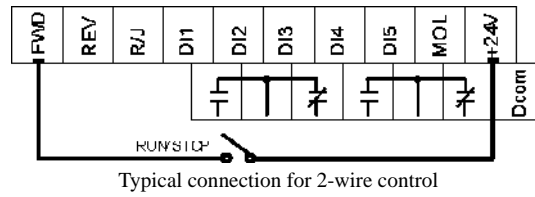

Figure 4-4: Connections for 2-wire and 3-wire Control

Table 4-8: Selection of Preset Speeds

PS3 (Bit 3)	PS2 (Bit 2)	PS1 (Bit 1)	Speed Selected
0	0	0	Normal reference speed as defined by parameters <b>201 (Input Mode)</b> and <b>204 (Ref Select)</b>
0	0	1	Preset frequency F1 ( <b>303-F1</b> ).
0	1	0	Preset frequency F2 ( <b>304-F2</b> ).
0	1	1	Preset frequency F3 ( <b>305-F3</b> ).
1	0	0	Preset frequency F4 ( <b>306-F4</b> ).
1	0	1	Preset frequency F5 ( <b>307-F5</b> ).
1	1	0	Preset frequency F6 ( <b>308-F6</b> ).
1	1	1	Maximum frequency ( <b>302, Max Frequency</b> ).

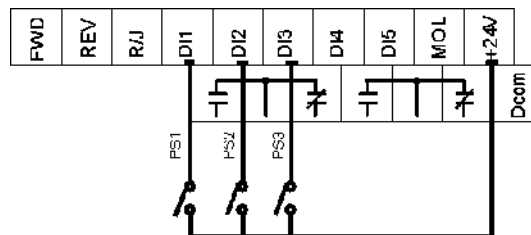

Figure 4-5: Connections for Preset Speeds

### 4.6.3 Typical Connection Diagrams for Analog Inputs

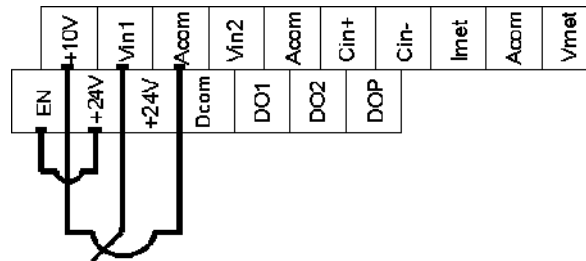

Figure 4-6: Connections for Speed Potentiometer

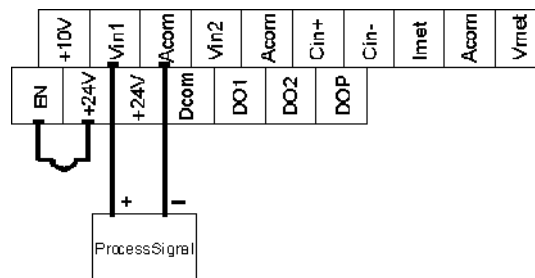

Figure 4-7: Connections for Process Signal

### 4.6.4 Typical Connection Diagrams for Analog Outputs

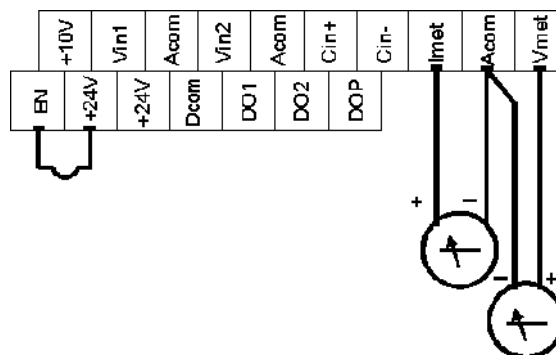

Figure 4-8: Connections for Process Meters

---

## Chapter 5: Keypad Operation and Programming

### 5.1 Introduction

The X4 AC drive is pre-programmed to run a standard, 4-pole AC induction motor. For many applications, the drive is ready for use right out of the box with no additional programming needed. The digital keypad controls all operations of the unit. The ten input keys allow “press and run” operation of the motor (Operation mode) and straightforward programming of the parameters (Program mode)..



**Figure 5-1: The X4 Keypad**

To simplify programming, the parameters are grouped into three levels:

1. Enter **Level 1** by pressing the Program (PROG) key at any time. Level 1 allows you to access the most commonly used parameters.
2. Enter **Level 2** by holding down the SHIFT key while pressing the PROG key. Level 2 allows access to all X4 parameters, including those in Level 1, for applications which require more advanced features.
3. Enter **Macro mode** by holding the Program (PROG) key down for more than 3 seconds. The display then shows “Hold PROG for Macro Mode.” See Chapter 6, “Using Macro Mode,” starting on page 39, for more information.











The summary of parameters found before the Table of Contents notes whether a parameter is in Level 1. “Chapter 7: X4 Parameters” on page 49 gives full information about what level a parameter is in.

If you want to get started quickly, see the “Quick Start” section on page 48.

## 5.2 Keypad Operation





Parameter **201, Input Mode** (see page 52), determines whether the X4 AC drive accepts its Run/ Stop and speed commands from the digital keypad or from the input terminals. Table 5-1 describes the function of the keys in Operation mode.

**Table 5-1: Function of Keys in Operation Mode (X4 Running or Stopped)**



	Initiates forward run when pressed momentarily. If the drive is running in reverse when FWD is pressed, it will decelerate to zero speed, change direction, and accelerate to the set speed. The green FWD designation in the key illuminates whenever a FWD command has been given. When both the FWD and REV lights are on, the DC braking function is active.
	Initiates reverse run when pressed momentarily. If the drive is running in forward when REV is pressed, it will decelerate to zero speed, change direction, and accelerate to the set speed. The green REV in the key illuminates whenever a REV command has been issued. When both the FWD and REV lights are on, the DC braking function is active.
	Causes a Ramp-to-Stop when pressed. Programmable to Coast-to-Stop by parameter <b>401, Ramp Select</b> (page 56). The red STOP indicator in the key illuminates whenever a STOP command has been given. If the drive has stopped because of a fault, this indicator flashes to call attention to the display.
	Press the Jog button to enter the Jog mode. The green JOG indicator in the key illuminates when the drive is in the JOG mode of operation. To jog the motor in either direction, press either the FWD or REV (if REV is enabled in parameter <b>202</b> ). The motor will operate at the speed programmed in parameter <b>303</b> . To exit the Jog mode, press the Jog key again.
	When the drive is stopped, pressing this key increases the desired running speed. When the drive is running, pressing this key increases the actual running speed in <b>0.1 Hz increments</b> . Holding the SHIFT key while pressing the UP arrow moves the decimal place to the left with each press (0.1 Hz, 1.0 Hz, 10.0 Hz increments).
	When the drive is stopped, pressing this key decreases the desired running speed. When the drive is running, pressing the DOWN key decreases the actual running speed in <b>0.1 Hz increments</b> . Holding the SHIFT key while pressing the DOWN arrow moves the decimal place to the right with each press (10.0 Hz, 1.0 Hz, 0.1 Hz increments).
	<b>NOTE: The operating speed for the drive is stored on Power Down.</b>
	Pressing this key while a parameter is displayed allows that parameter to have its value changed by use of the UP and DOWN arrow keys. The P indicator flashes to show that the parameter can be programmed. See also the descriptions for the UP and DOWN arrows above to see how they work with the SHIFT key.
	The Enter key has no function when the drive is running or stopped. The Enter key can be used to store the speed command so that it is saved through a power-down. To enable this function, see the description for parameter <b>802</b> (Start Options) on page 69.
	Whether the drive is running or stopped, pressing this key places the drive in Program mode. See Table 5-2 on page 32 for more information on how this key functions.
	Pressing this key toggles drive control between the LOCAL and REMOTE control modes, as selected by parameter <b>201</b> (Mode). It can be configured to shift: <ul style="list-style-type: none"> <li>the Run/Stop command (either FWD or REV)</li> <li>the speed reference signal</li> <li>both of the above</li> </ul> It can also be set to "disabled," which is the factory setting. It will operate either in Stop mode or while the drive is running. If power is removed and reapplied, the memory will retain the last selected function.

**Program mode** is entered by stopping the X4 drive and pressing the **Program (PROG)** key for Level 1 access; or holding down **SHIFT** while pressing **PROG** for Level 2 access. Pressing and holding the **Enter** key and then pressing the **Program** key will show only those parameters that have been changed from the factory defaults. Table 5-2 describes the function of the keys in Program mode.

**Table 5-2: Function of Keys in Program Mode**

	Press this key to have the drive enter Program mode and have Level 1 parameters available. (To access Level 2 parameters, hold down SHIFT while pressing this key; to access Macro mode, hold down the PROG key for more than 3 seconds.) Once Program mode is active, pressing this key at any time returns the drive to the Operation mode. If an Access Code has been programmed, it must be entered to proceed with programming. See Parameter <b>811 (ACODE)</b> (page 70).
<i>NOTE: To see what parameters have changed from the factory default, press ENTER + PROG. If the display flashes "Factory Defaults," no parameters have changed.</i>	
	In the Program mode, pressing this key scrolls <b>forward</b> through the parameters. If the P indicator is flashing, it increases the value of the parameter. To change the scroll rate, hold the SHIFT key at the same time to increase the scroll rate; release the SHIFT key to return to the normal scroll rate. Press the ENTER key to store the new value.
	In the Program mode, pressing this key scrolls <b>backward</b> through the parameters. If the P indicator is flashing, it decreases the value of the parameter. To change the scroll rate, hold the SHIFT key at the same time to increase the scroll rate; release the SHIFT key to return to the normal scroll rate. Press the ENTER key to store the new value.
<i>NOTE: If the P indicator on the keypad display is flashing, momentarily pressing and releasing both the UP and DOWN arrows at the same time restores the parameter to the factory default value. Press ENTER to store the new value.</i>	
	Pressing this key while a parameter is displayed allows that parameter to have its value changed by use of the UP and DOWN arrow keys. The P indicator flashes to show that the parameter can be programmed. See also the descriptions for the UP and DOWN arrows above to see how they work with the SHIFT key.
	This key must be pressed after the value of a parameter has been changed to store the new value. The display will show "stored" for one second indicating that the new value has been entered into memory.
<i>NOTE: The X4 unit allows you to view only those parameters that have changed. If you press keypad keys ENTER and PROGRAM simultaneously, only those parameters that have been changed from the factory defaults will be shown.</i>	

**Table 5-3: Function of Keys in Fault Mode**

	In Fault mode, pressing the UP and DOWN keys allows the operator to view the drive's status immediately before the fault occurred. Use the UP and DOWN arrows to scroll through the status parameters. Press the STOP (Reset) key to return to normal operation.
	See "Chapter 8: Troubleshooting" on page 83 for information about viewing Advanced Fault Codes and understanding error codes.
	The red STOP indicator functions as a reset button when in Fault mode. If the drive has stopped because of a fault, this light flashes to call attention to the display.



## 5.3 LCD Displays

The X4 drive's digital keypad display provides information such as source of drive control, status, mode, and access rights.

### 5.3.1 Control

The first 3 characters of the display show the source of control for the drive:

Display Values	Meaning
LOC	Local control via the keypad
REM	Remote control from the terminal strip
SIO	Remote control via the RS485 Serial SIO Link
SQx	Control via the Program Sequencer

### 5.3.2 X4 Keypad Status and Warning Messages

Table 5-4 shows X4 keypad status messages that may appear during operation:

**Table 5-4: Keypad Status States** (Page 1 of 2)

Message	Meaning
Stopped	The drive is not spinning the motor or injecting DC voltage. The drive is ready to run when given the proper signal.
FWD Accel	The drive is spinning the motor in the forward direction and the speed of the motor is increasing.
REV Accel	The drive is spinning the motor in the reverse direction and the speed of the motor is increasing.
FWD Decel	The drive is spinning the motor in the forward direction and the speed of the motor is decreasing.
REV Decel	The drive is spinning the motor in the reverse direction and the speed of the motor is decreasing.
Jog FWD	The drive is jogging in the forward direction.
Jog REV	The drive is jogging in the reverse direction.
FWD At Spd	The drive is spinning the motor in the forward direction and the speed of the motor is at the reference frequency.
REV At Spd	The drive is spinning the motor in the reverse direction and the speed of the motor is at the reference frequency.
Zero Speed	The drive has an active run signal but the motor is not spinning because the reference speed to the drive must be 0.0 Hz.
DC Inject	The drive is injecting DC voltage into the motor.
Faulted	The drive is faulted.
Reset-Flt	The drive is faulted, but has the possibility of being automatically reset.
LS Lockout	Line-Start Lockout functionality has become active. This means there was an active run signal during power-up or when a fault was reset. This run signal must be removed before the Line-Start Lockout functionality will be removed.
Catch Fly	The Catch on the Fly functionality is actively searching for the motor frequency.
Forward	The drive is running forward without accelerating, decelerating or residing at the reference frequency. This means that something is keeping the drive from the reference frequency (for example, Current Limit).

**Table 5-4: Keypad Status States** (Page 2 of 2)

Message	Meaning
Reverse	The drive is running in reverse without accelerating, decelerating or residing at the reference frequency. This means that something is keeping the drive from the reference frequency (for example, Current Limit).
Not Enabled	The drive is not allowed to run either because the digital input enable is not active or because ARCTIC mode has shut down the run operation.
Volt Range	The drive has not met the input voltage requirements that it needs to be able to run. In other words, the Bus Voltage of the drive is either too low or too high.
Low Voltage	The drive has reached an undervoltage state.
Kpd Stop	A stop command was given from the keypad when the keypad was not the active control source. To remove this condition, the run signal to the drive must be removed.

Table 5-5 shows X4 keypad warning messages that may appear during operation:

**Table 5-5: Keypad Warnings**

Message	Meaning
DB Active	The DB Resistor is being actively pulsed.
Curr Limit	The drive is operating in current limit.
HS Fan Err	Either the heatsink fan should be on and is off, or vice-versa.
Addr XXX	This is the node address of the drive when it receives a valid message through the IR port address to another node. The XXX will be replaced with the node address.
High Temp	The temperature of either the heatsink or the control board is nearing a high temperature limit that will fault the drive.
Low Temp	The temperature of either the heatsink or the control board is nearing a low temperature limit that will fault the drive.
Vac Imblnce	Either the drive has lost an input phase or the input voltage is unbalanced more than 2%.
Power Supp	A power supply short occurred.
Seq Dwell	The sequencer is active, but the transition to the next step is halted.
Int Fan Err	Either the internal fan is on and should be off, or vice-versa.
DB OverTemp	The temperature of the DB Resistor is nearing a high temperature and will fault the drive.
ARCTIC Mode	The ARCTIC DB Resistor mode is actively pulsing the DB Resistor.
CPU Warning	A system error occurred in the software of the X4.
Mtr Measure	An RS Measurement is armed or active.
IR Active	Valid IR communications are occurring.
Seq Running	The program sequencer functionality is active.

### 5.3.3 Rights

After Program mode is entered, the operator's access rights are displayed:

Display Values		
ACCESS RIGHTS	<b>P</b>	This indicates that while in Programming mode, parameter data can be changed.
	<b>V</b>	If the drive is in Run mode (FWD or REV) when the PROG key was pressed, parameters can be viewed, but not changed.
	The first character of the second line indicates if the particular parameter can be changed ( <b>P</b> ) or only examined ( <b>V</b> ). If an attempt is made to change data while in the View (V) mode, the message <b>**NO ACCESS**</b> will appear for one second.	

### 5.3.4 Other Data

The top line gives 16-character description of the parameter being accessed. The parameter number will flash when data is being changed. Up to 10 characters are used to display the information stored in the parameter. Some parameters have a unit designator such as:

<b>s</b>	Seconds
<b>h</b>	Hours
<b>C</b>	Degrees centigrade
<b>Hz</b>	Hertz
<b>%</b>	Percent
<b>A</b>	Amperes

When the drive stops because of a fault trip, a unique error message will be displayed, along with the flashing STOP indicator. "Pages," or screens of information are available concerning the actual fault and drive status.

"Chapter 8: Troubleshooting" on page 83 gives information about fault codes and troubleshooting.

## 5.4 Keypad Display Window

The keypad display provides information on drive operation and programming. Special symbols provide further information about drive operation (see the following section). Figure 5-2 shows an example of the X4 keypad display.



Figure 5-2: X4 Keypad Display

## 5.5 Programming

### 5.5.1 Accessing Parameters

When PROG (or SHIFT+PROG) is pressed after application of power or a fault reset, parameter **201, Input Mode**, is always the first parameter displayed. Figure 5-3 shows a typical programming display.



Figure 5-3: Typical Programming Display

If a different parameter is accessed and Program mode is exited, that parameter is the first one displayed the next time Program mode is entered. The drive remembers a different “last parameter accessed” for Levels 1 and 2.

### 5.5.2 Changing the Display Scroll Rate

Pressing the UP or DOWN arrows causes the display to scroll at a slow rate. To increase the scroll rate, hold the SHIFT key at the same time that you press the UP arrow. Release the SHIFT key to return to the slow scroll rate. This procedure works in all programming and operation modes.

### 5.5.3 Programming Procedure

To program the value of a parameter, follow these steps:

1. Press the Program (PROG) key to enter Level 1 Program mode. To enter Level 2, press SHIFT+PROG. The P indicator will appear on the display. You must enter one level of programming or the other; you cannot switch between levels without exiting Program mode.  
*Note that if you wish to program parameter 201, Input Mode, you must stop the drive before beginning programming. For all other parameters, the drive may be running or stopped.*
2. Press the UP/DOWN arrow keys to access the desired parameter.
3. Press the SHIFT key to allow the value to be changed. The P indicator starts to blink.
4. Press the UP/DOWN arrows to select the new value.
5. Press the ENTER key to store the new value. The display shows “Stored” for one second.
6. Press the PROG key to exit the Program mode, or the UP or DOWN arrows to select a new parameter.

### 5.5.4 Restoring Factory Settings

Whenever a parameter's value is being changed (noted by the P indicator flashing), the original factory setting for that parameter may be restored by pressing and releasing both the UP and DOWN arrows simultaneously and then pressing the ENTER key.

To restore ALL parameters to factory settings, or to recall a previously stored parameter set, see parameter **801, Program Number** (page 68).

### 5.5.5 Viewing Parameters That Have Changed

The X4 unit allows you to view only those parameters that have changed. If you press keypad keys ENTER and PROGram simultaneously, only those parameters that have been changed from the factory defaults will be shown. Note that all parameters, regardless of Level 1 or 2 default location, will be shown. If other parameters need to be changed, press the PROGram key to exit this mode in either Level 1 or 2, as needed.

### 5.5.6 Using Macro Mode

A special Macro programming mode is available with the X4 series of AC drives. The Macro programming mode allows you to customize the most common parameters for your application in the Level 1 group. Macro mode provides special parameters for activating modes of operation by macros, program sequencer, or serial communications.

Parameters that are important to the drive's operation are also included in the Macro mode. Although these parameters are also available with standard programming, the Macro mode allows you to quickly and easily configure the drive with essential parameters.

See "Chapter 6: Using Macro Mode and Getting a Quick Start" on page 39, for detailed information about using macros to program the X4 drive.

## 5.6 Measuring Stator Resistance (RS Measurement)

### 5.6.1 Activating Automatic RS Measurement Using the Keypad

1. Make sure there is no load applied to the motor and that the motor shaft is free to spin without damage or injury.
2. Enter the Macro programming mode of the X4 keypad by pressing and holding the PROG key until the parameter "Appl Macro" appears on the keypad. This takes about two seconds.
3. Scroll through the parameters of the X4 Macro programming mode and configure the following parameters to the data provided on the nameplate of the motor:
  - Rated Volt (**509**)
  - Rated Mtr FLA (**510**)
  - Rated Mtr RPM (**511**)
  - Power Factor (**515**)
4. Change parameter "Find Mtr Data" (parameter **519**) to a value of "Motor RS." At this point, the RS Measurement will be armed.
5. Exit the Macro programming mode by pressing the PROG key.
6. The Operate screen shows in two ways that an RS Measurement is ready to be made. First, the Control path status field displays "MEA." Second, a "Mtr Measure" warning flashes, both of these signifying that a measurement is about to be taken.

7. Start the RS Measurement by pressing the FWD key. The measurement can only be made with the FWD key. The FWD / REV terminals and the REV key will not work.
8. The measurement will begin as the drive injects voltage to the motor at zero frequency. The test lasts about two seconds.
9. If the test was successful, the drive will stop and return to the configured control path. The "Motor RS" parameter will contain a new value that is the calculated resistance of the motor.
10. If the test was not successful, the drive will fault with a "RS Meas. Fail" message (Fault 34). If the test fails, you may want to try the test again with a different "Rated Mtr FLA" or different Current Limit percentage.

### 5.6.2 Activating Automatic RS Measurement via Serial Link (Modbus)

1. Make sure there is no load applied to the motor and that the motor shaft is free to spin without damage or injury.
2. Configure the following parameters to the data provided on the nameplate of the motor:
  - Rated Volt (**509**)
  - Rated Mtr FLA (**510**)
  - Rated Mtr RPM (**511**)
  - Power Factor (**515**)
3. Change parameter "Find Mtr Data" (**519**) to a value of "Motor RS." At this point, the RS Measurement will be armed.
4. Start the RS Measurement by writing a value of 0x0007 to parameter "SIO Cntl Word" (**904**).
5. The measurement begins as the drive injects voltage to the motor at zero frequency. The test lasts about two seconds.
6. If the test was successful, the drive will stop and return to the configured control path. The "Motor RS" parameter will contain a new value that is the calculated resistance of the motor.
7. If the test was not successful, the drive will fault with a "RS Meas. Fail" message (Fault 34). If the test fails, you may want to try the test again with a different "Rated Mtr FLA" or different Current Limit percentage.

---

## Chapter 6: Using Macro Mode and Getting a Quick Start

A special Macro programming mode is available with the X4 series of AC drives. The Macro programming mode allows you to customize quickly the most common parameters for your application in the Level 1 group. Macro mode provides special parameters for activating modes of operation by macros, program sequencer, or serial communications.

Parameters important to the drive's operation are also included in Macro mode. Although these parameters are also available with standard programming, the Macro mode allows you to easily configure the drive with essential parameters.

Macros configure what advanced functions will be active in the drive. A macro can also change the default or visibility of a parameter within the programming levels. **Parameter 490 (Appl Macro)** configures what macro will be active in the drive. **Parameter 491 (Seq Appl)** configures the visibility of sequencer parameters and the time base of the sequencer. **Parameter 492 (SIO Visible)** configures whether or not SIO parameters are visible. (See page 40.)

### 6.1 Entering Macro Mode

To enter the Macro mode, press and hold the PROGram key for more than three seconds. The drive then enters Macro mode and displays "Hold PROG for Macro Mode." Following is a list of the different macros available and their features. A description of parameters used in Macro mode begins on page 40.

<b>Factory</b>	The Factory macro provides a simple way to restore the factory default parameter listings.
<b>Fan</b>	The Fan macro provides a basic set-up for Fan applications. Parameters such as the V/Hz curve and terminal strip operation are available in Level 1 programming.
<b>Fan w/ PI</b>	The Fan w/ PI macro allows for a simple set-up for Fan applications requiring process control. Parameters such as the V/Hz curve, terminal strip operation, and PI configuration parameters are available in Level 1 programming.
<b>Pump</b>	The Pump macro provides a basic set-up for Pump applications. Parameters such as the V/Hz curve and terminal strip operation are available in Level 1 programming.
<b>Pump w/ PI</b>	The Pump w/ PI macro allows for a simple set-up for Pump applications requiring process control. Parameters such as the V/Hz curve, terminal strip operation, and PI configuration parameters are available in Level 1 programming.
<b>Vector</b>	The Vector macro activates the sensorless vector control algorithm. When an operation requires low speed and high torque, this macro should be activated.

## 6.2 Description of Parameters Used in Macro Mode

Parameters **490, 491, and 492** are used only in the Macro mode. Parameters **509, 510, 511, 801, and 810** are used in both Macro and Level 2 programming. X4 parameters are described in “Chapter 7: X4 Parameters” on page 49 of this manual.

<b>490 Appl Macro</b>	Default: Factory	Range: n/a Macro														
<p>This parameter configures what macro will be active in the drive. A macro will change a default or visibility of a parameter.</p> <p>The following data values may be assigned to this parameter:</p> <table border="1"> <thead> <tr> <th><u>Macro</u></th> <th><u>Description</u></th> </tr> </thead> <tbody> <tr> <td><b>Factory</b></td> <td>Provides a simple way to restore factory default parameter listings.</td> </tr> <tr> <td><b>Fan</b></td> <td>Provides a basic set-up for Fan applications, including V/Hz curve and terminal strip operation in Level 1 programming.</td> </tr> <tr> <td><b>Fan w/PI</b></td> <td>Provides a simple set-up for Fan applications that require process control. Parameters such as V/Hz curve, terminal strip operation, and PI configuration are available in Level 1 programming.</td> </tr> <tr> <td><b>Pump</b></td> <td>Provides a basic set-up for Pump applications, including V/Hz curve and terminal strip operation in Level 1 programming.</td> </tr> <tr> <td><b>Pump w/PI</b></td> <td>Provides a simple set-up for Pump applications requiring process control. Parameters such as V/Hz curve, terminal strip operation, and PI configuration are available in Level 1 programming.</td> </tr> <tr> <td><b>Vector</b></td> <td>Activates the sensorless vector control algorithm. When an operation requires low speed and high torque, this macro should be activated. Note that in Vector control, the drive automatically runs the Motor Rs measurements when leaving PROGRAM mode.</td> </tr> </tbody> </table>			<u>Macro</u>	<u>Description</u>	<b>Factory</b>	Provides a simple way to restore factory default parameter listings.	<b>Fan</b>	Provides a basic set-up for Fan applications, including V/Hz curve and terminal strip operation in Level 1 programming.	<b>Fan w/PI</b>	Provides a simple set-up for Fan applications that require process control. Parameters such as V/Hz curve, terminal strip operation, and PI configuration are available in Level 1 programming.	<b>Pump</b>	Provides a basic set-up for Pump applications, including V/Hz curve and terminal strip operation in Level 1 programming.	<b>Pump w/PI</b>	Provides a simple set-up for Pump applications requiring process control. Parameters such as V/Hz curve, terminal strip operation, and PI configuration are available in Level 1 programming.	<b>Vector</b>	Activates the sensorless vector control algorithm. When an operation requires low speed and high torque, this macro should be activated. Note that in Vector control, the drive automatically runs the Motor Rs measurements when leaving PROGRAM mode.
<u>Macro</u>	<u>Description</u>															
<b>Factory</b>	Provides a simple way to restore factory default parameter listings.															
<b>Fan</b>	Provides a basic set-up for Fan applications, including V/Hz curve and terminal strip operation in Level 1 programming.															
<b>Fan w/PI</b>	Provides a simple set-up for Fan applications that require process control. Parameters such as V/Hz curve, terminal strip operation, and PI configuration are available in Level 1 programming.															
<b>Pump</b>	Provides a basic set-up for Pump applications, including V/Hz curve and terminal strip operation in Level 1 programming.															
<b>Pump w/PI</b>	Provides a simple set-up for Pump applications requiring process control. Parameters such as V/Hz curve, terminal strip operation, and PI configuration are available in Level 1 programming.															
<b>Vector</b>	Activates the sensorless vector control algorithm. When an operation requires low speed and high torque, this macro should be activated. Note that in Vector control, the drive automatically runs the Motor Rs measurements when leaving PROGRAM mode.															
<b>491 Seq Appl</b>	Default: Disabled	Range: n/a Macro														
<p>This parameter configures sequencer parameters are visible and the time base of the sequencer. The time base may change depending on the timing loops used.</p> <p>The following data values may be assigned to this parameter:</p> <table border="1"> <thead> <tr> <th><u>Macro Value</u></th> <th><u>Description</u></th> </tr> </thead> <tbody> <tr> <td><b>Disabled</b></td> <td>Sequencer disabled and parameters hidden.</td> </tr> <tr> <td><b>1sec Base</b></td> <td>Sequencer enabled and 1 second time base.</td> </tr> <tr> <td><b>.1sec Base</b></td> <td>Sequencer enabled and 0.1 second time base.</td> </tr> <tr> <td><b>.01sec Base</b></td> <td>Sequencer enabled and 0.01 second time base.</td> </tr> </tbody> </table>			<u>Macro Value</u>	<u>Description</u>	<b>Disabled</b>	Sequencer disabled and parameters hidden.	<b>1sec Base</b>	Sequencer enabled and 1 second time base.	<b>.1sec Base</b>	Sequencer enabled and 0.1 second time base.	<b>.01sec Base</b>	Sequencer enabled and 0.01 second time base.				
<u>Macro Value</u>	<u>Description</u>															
<b>Disabled</b>	Sequencer disabled and parameters hidden.															
<b>1sec Base</b>	Sequencer enabled and 1 second time base.															
<b>.1sec Base</b>	Sequencer enabled and 0.1 second time base.															
<b>.01sec Base</b>	Sequencer enabled and 0.01 second time base.															
<b>492 SIO Visible</b>	Default: No	Range: n/a Macro														
<p>This parameter configures whether SIO parameters are visible.</p> <p>The following data values may be assigned to this parameter:</p> <table border="1"> <thead> <tr> <th><u>Macro Value</u></th> <th><u>Description</u></th> </tr> </thead> <tbody> <tr> <td><b>No</b></td> <td>SIO parameters hidden.</td> </tr> <tr> <td><b>Yes</b></td> <td>SIO parameters visible.</td> </tr> </tbody> </table>			<u>Macro Value</u>	<u>Description</u>	<b>No</b>	SIO parameters hidden.	<b>Yes</b>	SIO parameters visible.								
<u>Macro Value</u>	<u>Description</u>															
<b>No</b>	SIO parameters hidden.															
<b>Yes</b>	SIO parameters visible.															
<b>509 Rated Mtr Volt</b>	Default: Model dependent	Range: 100 V - 690 V Level 2, Macro														
<p>The Rated Motor Voltage parameter configures the rated motor voltage, and allows a user to enter the rated voltage from the motor nameplate to provide optimal control and protection. This is usually the amount of voltage delivered to the motor terminals at the setting of <b>503 (V/Hz Knee Freq)</b>.</p>																
<b>510 Rated Mtr FLA</b>	Default: ND Rating	Range: 50% of ND rating - 200% of ND rating Level 2, Macro														
<p>The Rated Motor FLA parameter allows a user to enter the rated FLA from the motor nameplate to provide optimal control and protection. This parameter should be configured to the value on the nameplate of the motor, as that value is used in calculating the percentage of current at which the drive is operating.</p> <p>For information on motor timed overload operation, and how Parameter <b>510</b> works with it, see page 64.</p>																



<b>511 Rated Mtr RPM</b>	Default: 1750 rpm	Range: 0-24000 rpm Level 2, Macro												
This parameter replaces the slip compensation parameter setting of the drive so the user does not need to calculate it.														
<b>514 Motor RS</b>	Default: 1.00 Ohm	Range: 0.00-655.35 Ohms Level 2												
This parameter allows direct entry of the Stator Resistance (Rs) of the motor for better vector performance. The motor manufacturer can provide this information. See "Measuring Stator Resistance (RS Measurement)" on page 37.														
<b>515 Power Factor</b>	Default: 0.80	Range: 0.50 - 1.00 Level 2												
This parameter allows direct entry of the motor's power factor for better vector performance. The motor manufacturer can provide this information.														
<b>519 Find Mtr Data</b>	Default: Not active	Range: n/a Macro												
This parameter activates the drive's ability to measure the stator resistance of the attached motor. The automatic stator resistance measurement can be performed either through the keypad or through the serial link. See "Measuring Stator Resistance (RS Measurement)" on page 37 for more information about this parameter. The following data values may be assigned:														
<table border="0"> <thead> <tr> <th><u>Parameter Value</u></th> <th><u>Description</u></th> </tr> </thead> <tbody> <tr> <td>Not Active</td> <td>No stator RS measurement.</td> </tr> <tr> <td>Motor RS</td> <td>Automatic RS measurement using macro procedure.</td> </tr> </tbody> </table>			<u>Parameter Value</u>	<u>Description</u>	Not Active	No stator RS measurement.	Motor RS	Automatic RS measurement using macro procedure.						
<u>Parameter Value</u>	<u>Description</u>													
Not Active	No stator RS measurement.													
Motor RS	Automatic RS measurement using macro procedure.													
<b>801 Program Number</b>	Default: 0	Range: 0 to 9999 Level 2, Macro												
This parameter (Special Program Number) provides a method of enabling hidden functions in the drive and storing parameters to the customer set.														
<table border="0"> <thead> <tr> <th><u>Data Value</u></th> <th><u>Special Function Configured</u></th> </tr> </thead> <tbody> <tr> <td>0</td> <td>Standard program</td> </tr> <tr> <td>1</td> <td>Reset all parameters to factory default values (display = SETP).</td> </tr> <tr> <td>2</td> <td>Store customer parameter values (display = STOC).</td> </tr> <tr> <td>3</td> <td>Load customer parameter values (display = SETC).</td> </tr> <tr> <td>4</td> <td>Swap active parameters with customer stored settings.</td> </tr> </tbody> </table>			<u>Data Value</u>	<u>Special Function Configured</u>	0	Standard program	1	Reset all parameters to factory default values (display = SETP).	2	Store customer parameter values (display = STOC).	3	Load customer parameter values (display = SETC).	4	Swap active parameters with customer stored settings.
<u>Data Value</u>	<u>Special Function Configured</u>													
0	Standard program													
1	Reset all parameters to factory default values (display = SETP).													
2	Store customer parameter values (display = STOC).													
3	Load customer parameter values (display = SETC).													
4	Swap active parameters with customer stored settings.													
<b>810 Language</b>	Default: English	Range: 1-65535 Level 2, Macro												
This parameter configures the language in which text strings will be displayed.														
The following data values may be assigned to this parameter:														
<table border="0"> <thead> <tr> <th><u>Parameter Value</u></th> </tr> </thead> <tbody> <tr> <td>English</td> </tr> <tr> <td>Spanish</td> </tr> <tr> <td>German</td> </tr> <tr> <td>Italian</td> </tr> <tr> <td>French</td> </tr> </tbody> </table>			<u>Parameter Value</u>	English	Spanish	German	Italian	French						
<u>Parameter Value</u>														
English														
Spanish														
German														
Italian														
French														

### 6.3 Macro Mode Applications and Included Parameters

The tables below list the different applications and the Level 1 parameters included in the macro for that application. The Factory Application macro is the core package (listed in Table 6-1); the other macros include the Factory Application macro parameters as well as the ones listed in their respective tables (Tables 6-2, 6-3, 6-4, 6-5, and 6-6). The macro mode applications are as follows:

Factory Application (Table 6-1)

Fan Application (Table 6-2)

Fan with PI Application (Table 6-3)

Pump Application (Table 6-4)

Pump with PI Application (Table 6-5)

Vector Application (Table 6-6)

**Table 6-1: Factory Application Macro**

Para. #	Parameter Name	Default	See Page
001	Model Number	Read-only	50
010	Last Fault	Read-only	50
102	Output Freq	Read-only	51
103	Output Voltage	Read-only	51
104	Output Current	Read-only	51
105	Drive Load	Read-only	51
106	Load Torque	Read-only	51
107	Drive Temp	Read-only	51
111	DC Bus Voltage	Read-only	51
201	Input Mode	Local Only	52
202	Rev Enable	Forward	52
301	Min Frequency	0.0 Hz	55
302	Max Frequency	60.0 Hz	55
303	Preset Freq 1	5.0 Hz	55
402	Accel Time 1	5.0 sec	56
403	Decel Time 1	5.0 sec	56
502	Voltage Boost	0.0%	59
610	Timed OL Select	Std Ind 60s	64
700	Vmet Config	Freq Out	65
705	Relay 1 Select	Drv Fault	66
706	Relay 2 Select	Drive Run	66

**Table 6-2: Fan Application Macro** (Core Factory Application from Table 6-1, **plus** the following parameters)

Para. #	Parameter Name	Default	See Page
203	Stop Key Remote	Coast	52
204	Ref Select	Vin1	53
205	Vin1 Config	0-10 V	53
206	Vin1 Offset	0.00%	53
207	Vin1 Span	100.00%	54
406	DC Inject Config	DC at Start	57
501	V/Hz Select	Linear 2pc	59
504	Skip Freq Band	0.2 Hz	60
505	Skip Freq 1	0.0 Hz	60
608	Restart Number	0	64
609	Restart Delay	60 sec	64
702	Imet Config	Current Out	65
703	Imet Span	100.0%	65
704	Imet Offset	0.0%	65
721	DI1 Configure	Preset 1	67
722	DI2 Configure	Preset 2	67
723	DI3 Configure	Preset 3	67
724	DI4 Configure	Ref Switch	67
725	DI5 Configure	Fault Reset	67
803	PWM Frequency	16.0 kHz	69
804	Display Mode	Output Freq	69

**Table 6-3: Fan with PI Application Macro** (Core Factory Application from Table 6-1, **plus** the following parameters)

Para. #	Parameter Name	Default	See Page
203	Stop Key Remote	Coast	52
204	Ref Select	Vin1	53
205	Vin1 Config	0-10 V	53
206	Vin1 Offset	0.00%	53
207	Vin1 Span	100.00%	54
208	Cin Config	0-20 mA 50	54
209	Cin Offset	0.0%	54
210	Cin Span	100.0%	54
211	Vin2 Config	0-10 V	54
212	Vin2 Offset	0.00%	54
213	Vin2 Span	100.00%	54
401	Ramp Select	ART-Strt/RS	56
406	DC Inject Config	DC at Start	57
501	V/Hz Select	Linear 2pc	59
504	Skip Freq Band	0.2 Hz	60
505	Skip Freq 1	0.0 Hz	60
608	Restart Number	0	64
609	Restart Delay	60 sec	64
702	Imet Config	Current Out	65
703	Imet Span	100.0%	65
704	Imet Offset	0.0%	65
721	DI1 Configure	Preset 1	67
722	DI2 Configure	Preset 2	67
723	DI3 Configure	Preset 3	67
724	DI4 Configure	Ref Switch	67
725	DI5 Configure	PI Enable	67
803	PWM Frequency	16.0 kHz	69
804	Display Mode	Output Freq	69
850	PI Configure	No PI	71
851	PI Feedback	Vin1	71
852	PI Prop Gain	0	72
853	PI Int Gain	0	72
854	PI Feed Gain	1000	72
857	PI High Corr	100.00	72
858	PI Low Corr	0.00%	72

**Table 6-4: Pump Application Macro** (Core Factory Application from Table 6-1, **plus** the following parameters)

<b>Para. #</b>	<b>Parameter Name</b>	<b>Default</b>	<b>See Page</b>
203	Stop Key Remote	Coast	52
204	Ref Select	Vin1	53
205	Vin1 Config	0-10 V	53
206	Vin1 Offset	0.00%	53
207	Vin1 Span	100.00%	54
401	Ramp Select	ART-Strt/RS	56
501	V/Hz Select	Pump Fxd	59
608	Restart Number	0	64
609	Restart Delay	60 sec	64
702	Imet Config	Current Out	65
703	Imet Span	100.0%	65
704	Imet Offset	0.0%	65
721	D11 Configure	Preset 1	67
722	D12 Configure	Preset 2	67
723	D13 Configure	Preset 3	67
724	D14 Configure	Ref Switch	67
725	D15 Configure	Fault Reset	67
803	PWM Frequency	16.0 kHz	69
804	Display Mode	Output Freq	69

**Table 6-5: Pump with PI Application Macro** (Core Factory Application from Table 6-1, **plus** the following parameters)

Para. #	Parameter Name	Default	See Page
203	Stop Key Remote	Coast	52
204	Ref Select	Vin1	53
205	Vin1 Config	0-10 V	53
206	Vin1 Offset	0.00%	53
207	Vin1 Span	100.00%	54
208	Cin Config	0-20 mA 50	54
209	Cin Offset	0.0%	54
210	Cin Span	100.0%	54
211	Vin2 Config	0-10 V	54
212	Vin2 Offset	0.00%	54
213	Vin2 Span	100.00%	54
401	Ramp Select	ART-Strt/RS	56
406	DC Inject Config	DC at Stop	57
501	V/Hz Select	Pump Fxd	59
504	Skip Freq Band	0.2 Hz	60
505	Skip Freq 1	0.0 Hz	60
608	Restart Number	0	64
609	Restart Delay	60 sec	64
702	Imet Config	Current Out	65
703	Imet Span	100.0%	65
704	Imet Offset	0.0%	65
721	DI1 Configure	Preset 1	67
722	DI2 Configure	Preset 2	67
723	DI3 Configure	Preset 3	67
724	DI4 Configure	Ref Switch	67
725	DI5 Configure	PI Enable	67
803	PWM Frequency	16.0 kHz	69
804	Display Mode	Output Freq	69
850	PI Configure	No PI	71
851	PI Feedback	Vin1	71
852	PI Prop Gain	0	72
853	PI Int Gain	0	72
854	PI Feed Gain	1000	72
857	PI High Corr	100.00	72
858	PI Low Corr	0.00%	72

**Table 6-6: Vector Application Macro** (Core Factory Application from Table 6-1, **plus** the following parameters)

<b>Para. #</b>	<b>Parameter Name</b>	<b>Default</b>	<b>See Page</b>
501	V/Hz Select	Vector	59
509	Rated Mtr Volt	Model dependent	60
510	Rated Mtr FLA	ND rating	60
511	Rated Mtr RPM	1750 rpm	60
514	Motor RS	Model dependent	60
515	Power Factor	0.8	60
516	Slip Comp Enable	No	61
519	Find Mtr Data	Not Active	61
520	Filter FStator	8 mS	61
521	Start Field En	No	61
522	Filter Time Slip	100 mS	61
523	Id Percent	Read-only	62
524	Iq Percent	Read-only	62
803	PWM Frequency	3.0 kHz	69
804	Display Mode	Std Display	69

## 6.4 Quick Start

The following procedure is for operators using simple applications, who would like to get started quickly. *Be sure to read and understand all the sections in this chapter before proceeding with these instructions.* If you are using remote operators, substitute the speed potentiometer for the UP and DOWN arrows, and the remote Run/Stop switch for the FWD key in the following instructions.

### CAUTION

#### IMPROPER EQUIPMENT COORDINATION

Verify that proper voltage is connected to the drive before applying power.

**Failure to observe this instruction can result in injury or equipment damage.**

### ATTENTION

#### MAUVAISE COORDINATION DES APPAREILS

Vérifiez que l'onduleur est raccordée à la bonne tension avant de le mettre sous tension.

**Si cette directive n'est pas respectée, cela peut entraîner des blessures corporelles ou des dommages matériels.**

1. Follow all precautions and procedures in “Chapter 3: Receiving and Installation” on page 12.
2. Apply AC power to the input terminals. For about 2 seconds the display will show all segments active. The display then changes to zeros.
3. The factory settings are for keypad-only operation in the forward direction—that is, the REV key is disabled. Press the FWD key, which causes the FWD indicator to illuminate.
4. Press the UP arrow to increase the desired running frequency. When the display gets to 0.1 Hz, the drive starts to produce an output.
5. When the motor starts to turn, check the rotation. If the motor is turning in the wrong direction, *press STOP, remove AC power, and wait for all indicators to go out.* After the STATUS indicator has gone out, reverse any two of the motor leads at T1/U, T2/V, or T3/W.
6. The X4 drive is preset to run a typical NEMA B 4-pole induction motor to a maximum speed of 60.0 Hz with both acceleration and deceleration times set to 5.0 seconds.
7. Use the Arrow keys to set the proper running speed of the motor and the FWD and STOP keys to control its operation.



---

## Chapter 7: X4 Parameters

### 7.1 Introduction

The X4 AC drive incorporates a comprehensive set of parameters that allow you to configure the device to meet the special requirements of your particular application.

Note that pressing the PROG key enters Level 1 programming. Press SHIFT+PROG to enter Level 2 programming. Press ENTER+PROG to show only those parameters that have changed from the factory default values.

This chapter describes the available parameters and the values that may be assigned to them. The parameter summary table at the front of this manual provides a summary of all parameters including their ranges and default values.

### 7.2 Level 1 Parameters

The most commonly configured X4 parameters are stored in a group named Level 1. This group is easily accessed by pressing the PROG key as described in “Chapter 5: Keypad Operation and Programming” on page 30. The following table lists the parameters in this group; for further information on the parameter, please turn to the indicated page.

**Table 7-1: Parameters Available in Level 1 Programming (Factory Macro)**

Para. #	Parameter Name	See Page	Para. #	Parameter Name	See Page
001	Model Number	50	303	Preset Freq 1	55
010	Last Fault	50	402	Accel Time 1	56
102	Output Freq	51	403	Decel Time 1	56
103	Output Voltage	51	502	Voltage Boost	59
104	Output Current	51	610	Timed OL Select	64
105	Drive Load	51	700	Vmet Config	65
106	Load Torque	51	705	Relay 1 Select	66
107	Drive Temp	51	706	Relay 2 Select	66
111	DC Bus Voltage	51			
201	Input Mode	52			
202	Rev Enable	52			
301	Min Frequency	55			
302	Max Frequency	55			

### 7.3 Description of Parameters

Table 7-2 lists the X4 parameters in the order in which they appear in the keypad display. For each parameter, the table lists the default value and range and also describes the use of the parameter.

**Table 7-2: Description of X4 Parameters** (Page 1 of 26)

<b>001 Model Number</b>	Read-Only	Range: n/a Level: 1,2
Parameter <b>001</b> , the <b>Model Number</b> parameter, contains the portion of the X4 model number related to voltage and horsepower. The number format is <i>vvhhf</i> , where <i>vv</i> is the code for the input voltage (19=115 Vac single-phase; 20=230 Vac, three-phase; 40=460 Vac, three-phase; 50=575 Vac, three-phase); <i>hh</i> is horsepower; and <i>f</i> is the fractional part of the horsepower. Example: <b>20020</b> = 230 Vac, three-phase, 2.0 HP model.		
<b>002 Software Rev</b>	Read-Only	Range: 0.00-99.99 Level: 2
Parameter <b>002</b> , the <b>Software Revision</b> parameter, displays the software revision that is installed in the drive. <b>Options:</b> 0.00-99.99		
<b>003 Rated Current</b>	Read-Only	Range: 0.0-200.0 A Level: 2
Parameter <b>003</b> , the <b>Rated Current</b> parameter, displays the normal duty current rating of the model of drive.		
<b>005 Serial No 1</b>	Read-Only	Range: 0-65535 Level: 2
Parameter <b>005</b> , <b>Serial No 1</b> , contains a number that corresponds to the year and week in which the drive was manufactured.		
<b>006 Serial No 2</b>	Read-Only	Range: 0-65535 Level: 2
Parameter <b>006</b> , <b>Serial No 2</b> , contains a number that determines the number of the drive that was manufactured during the week of Serial No 1. <b>Options:</b> 0.00-99.99		
<b>010 Last Fault</b>	Read-Only	Range: n/a Level: 1,2
Parameter <b>010</b> , <b>Last Fault</b> , lists the fault that occurred most recently. For more information, refer to Chapter 8, Troubleshooting, beginning on page 83.		
<b>025 4th Fault</b>	Read-Only	Range: n/a Level: 2
Parameter <b>025</b> , <b>4th Fault</b> , lists the fault that occurred 1 before the last fault. For more information, refer to Chapter 8, Troubleshooting, beginning on page 83.		
<b>040 3rd Fault</b>	Read-Only	Range:n/a Level: 2
Parameter <b>040</b> , <b>3rd Fault</b> , lists the fault that occurred 2 before the last. For more information, refer to Chapter 8, Troubleshooting, beginning on page 83.		
<b>055 2nd Fault</b>	Read-Only	Range: n/a Level: 2
Parameter <b>055</b> , <b>2nd Fault</b> , lists the fault that occurred 3 before the last. For more information, refer to Chapter 8, Troubleshooting, beginning on page 83.		
<b>070 1st Fault</b>	Read-Only	Range:n/a Level: 2
Parameter <b>070</b> , <b>1st Fault</b> , lists the fault that occurred 4 before the last. For more information, refer to Chapter 8, Troubleshooting, beginning on page 83.		

**Table 7-2: Description of X4 Parameters** (Page 2 of 26)

<b>102 Output Freq</b>	Read-Only	Range: 0.0 to 400.0 Hz Levels 1,2
Parameter <b>102</b> , the <b>Output Frequency</b> parameter, shows the frequency being applied to the motor connected to the drive (ramp).		
<b>103 Output Voltage</b>	Read-Only	Range: 0 to 600 V Levels 1,2
Parameter <b>103</b> , the <b>Output Voltage</b> parameter, displays the output voltage of the drive.		
<b>104 Output Current</b>	Read-Only	Range: 0.0 to 200.0 A Levels 1,2
Parameter <b>104</b> , the <b>Output Current</b> parameter, displays the output current of the drive.		
<b>105 Drive Load</b>	Read-Only	Range: -200.0% to 200.0% Levels 1,2
Parameter <b>105</b> , the <b>Drive Load</b> parameter, shows the percentage torque of the drive when operating below the knee frequency. It displays Load Torque if the frequency is below FKNEE, and displays Power if above FKNEE.  The output current is measured with the motor power factor applied to an accuracy of $\pm 20\%$ . The parameter value is positive when the motor is pulling a load ("motoring mode") and negative when being pulled by a load ("regenerative mode").		
<b>106 Load Torque</b>	Read-Only	Range: -200.0%-200.0% Levels 1,2
Parameter <b>106</b> , the <b>Load Torque</b> parameter, displays the load torque of the drive.		
<b>107 Drive Temp</b>	Read-Only	Range: -20.0 to 200.0 °C Levels 1,2
Parameter <b>107</b> , the <b>Drive Temp</b> parameter, shows the actual temperature of the drive's heatsink. The drive will fault when the internal temperature reaches 85°C.		
<b>108 Total Run Time</b>	Read-Only	Range: 0.0 - 6553.5 h Level: 2
Parameter <b>108</b> , <b>Total Run Time</b> , is a resettable timer for drive operation. To reset the timer, enter 10 in parameter <b>801</b> , <b>Program Number</b> .		
<b>109 Power On Hours</b>	Read-Only	Range: 0 - 65535 h Level: 2
Parameter <b>109</b> , <b>Power On Hours</b> , displays how long the drive has been powered up.		
<b>110 Stator Freq</b>	Read-Only	Range: 0.0-400.0 Hz Level: 2
Parameter <b>110</b> , <b>Stator Frequency</b> , displays the frequency the drive is applying to the motor stator.		
<b>111 DC Bus Voltage</b>	Read-Only	Range: 0-1000 Vdc Level: 1,2
Parameter <b>111</b> , <b>DC Bus Voltage</b> , displays the voltage on the DC bus.		
<b>115 Drive Power Out</b>	Read-Only	Range: 0.0%-200.0% Level: 2
This parameter displays the power being output by the drive in terms of drive rating. The measurement is calculated by scaling the Load Torque value by the ratio of Volt-Amps to Rated Volt-Amps, and adjusted by Output Frequency.		

**Table 7-2: Description of X4 Parameters** (Page 3 of 26)

201 Input Mode	Default = Local only	Range: n/a Levels 1,2																				
Parameter <b>201</b> , the <b>Input Mode</b> parameter, configures local and remote control of the Start/Stop source and the reference source.																						
The following data values may be assigned to this parameter:																						
<table border="0"> <thead> <tr> <th data-bbox="315 464 477 485"><u>Parameter Value</u></th> <th data-bbox="505 464 667 485"><u>Run/Stop Control</u></th> </tr> </thead> <tbody> <tr> <td data-bbox="315 499 407 520">Local only</td> <td data-bbox="505 499 760 520">Local keypad operation only</td> </tr> <tr> <td data-bbox="315 531 428 552">Remote only</td> <td data-bbox="505 531 760 552">Terminal strip operation only</td> </tr> <tr> <td data-bbox="315 562 431 583">L/R Rem Ref</td> <td data-bbox="505 562 1036 615">LOCal Keypad Start/Stop and Speed REMote Keypad Start/Stop, Terminal Strip Speed Reference</td> </tr> <tr> <td data-bbox="315 625 423 646">L/R Rem Ctl</td> <td data-bbox="505 625 1036 678">LOCAl Keypad Start/Stop and Speed REMote Keypad Speed Reference, Terminal Strip Start/Stop</td> </tr> <tr> <td data-bbox="315 688 428 709">L/R Rem Bth</td> <td data-bbox="505 688 997 741">LOCAl Keypad Start/Stop and Speed REMote Terminal Strip Start/Stop and Speed Reference</td> </tr> <tr> <td data-bbox="315 741 440 762">EMOP<sup>{1}</sup> {2} {4}</td> <td data-bbox="505 741 1013 762">Terminal strip operation using Increase/Decrease buttons</td> </tr> <tr> <td data-bbox="315 772 451 793">EMOP2<sup>{1}</sup> {3} {4}</td> <td data-bbox="505 772 1013 793">Terminal strip operation using Increase/Decrease buttons</td> </tr> <tr> <td data-bbox="315 804 483 825">LOC/EMOP<sup>{1}</sup> {2} {4}</td> <td data-bbox="505 804 1019 856">LOCAl Keypad Start/Stop and Speed REMote Terminal strip operation using Increase/Decrease</td> </tr> <tr> <td data-bbox="315 856 493 877">LOC/EMOP2<sup>{1}</sup> {3} {4}</td> <td data-bbox="505 856 1019 909">LOCAl Keypad Start/Stop and Speed REMote Terminal strip operation using Increase/Decrease</td> </tr> </tbody> </table>			<u>Parameter Value</u>	<u>Run/Stop Control</u>	Local only	Local keypad operation only	Remote only	Terminal strip operation only	L/R Rem Ref	LOCal Keypad Start/Stop and Speed REMote Keypad Start/Stop, Terminal Strip Speed Reference	L/R Rem Ctl	LOCAl Keypad Start/Stop and Speed REMote Keypad Speed Reference, Terminal Strip Start/Stop	L/R Rem Bth	LOCAl Keypad Start/Stop and Speed REMote Terminal Strip Start/Stop and Speed Reference	EMOP <sup>{1}</sup> {2} {4}	Terminal strip operation using Increase/Decrease buttons	EMOP2 <sup>{1}</sup> {3} {4}	Terminal strip operation using Increase/Decrease buttons	LOC/EMOP <sup>{1}</sup> {2} {4}	LOCAl Keypad Start/Stop and Speed REMote Terminal strip operation using Increase/Decrease	LOC/EMOP2 <sup>{1}</sup> {3} {4}	LOCAl Keypad Start/Stop and Speed REMote Terminal strip operation using Increase/Decrease
<u>Parameter Value</u>	<u>Run/Stop Control</u>																					
Local only	Local keypad operation only																					
Remote only	Terminal strip operation only																					
L/R Rem Ref	LOCal Keypad Start/Stop and Speed REMote Keypad Start/Stop, Terminal Strip Speed Reference																					
L/R Rem Ctl	LOCAl Keypad Start/Stop and Speed REMote Keypad Speed Reference, Terminal Strip Start/Stop																					
L/R Rem Bth	LOCAl Keypad Start/Stop and Speed REMote Terminal Strip Start/Stop and Speed Reference																					
EMOP <sup>{1}</sup> {2} {4}	Terminal strip operation using Increase/Decrease buttons																					
EMOP2 <sup>{1}</sup> {3} {4}	Terminal strip operation using Increase/Decrease buttons																					
LOC/EMOP <sup>{1}</sup> {2} {4}	LOCAl Keypad Start/Stop and Speed REMote Terminal strip operation using Increase/Decrease																					
LOC/EMOP2 <sup>{1}</sup> {3} {4}	LOCAl Keypad Start/Stop and Speed REMote Terminal strip operation using Increase/Decrease																					
<b>Notes:</b>																						
<ol style="list-style-type: none"> <li>Electronic Motor Operated Potentiometer (EMOP): simulates the UP/DOWN arrow keys on keypad using external remote N/O pushbuttons</li> <li>Commanded output frequency returns to the value of <b>parameter 301 (Min Frequency)</b> when the drive is stopped.</li> <li>Commanded output frequency remains at the previous setpoint when the drive is stopped.</li> <li>The parameters that set the functions of the designated digital inputs for EMOP must be configured as "EMOP+" and "EMOP-" to complete the implementation.</li> </ol>																						
202 Rev Enable	Default = Forward	Range: n/a Levels 1,2																				
Parameter <b>202</b> , the <b>Rev Enable</b> parameter, configures whether the REV key on the keypad is functional. If this parameter is configured to "Forward," then pressing the REV key on the keypad will have no effect. Note that this parameter does not affect terminal strip operation.																						
The following data values may be assigned to this parameter:																						
<table border="0"> <thead> <tr> <th data-bbox="315 1283 477 1304"><u>Parameter Value</u></th> <th data-bbox="505 1283 610 1304"><u>Description</u></th> </tr> </thead> <tbody> <tr> <td data-bbox="315 1325 391 1346">Forward</td> <td data-bbox="505 1325 797 1346">Forward Only, REV key disabled</td> </tr> <tr> <td data-bbox="315 1356 407 1377">FWD/REV</td> <td data-bbox="505 1356 764 1377">FWD and REV keys enabled</td> </tr> </tbody> </table>			<u>Parameter Value</u>	<u>Description</u>	Forward	Forward Only, REV key disabled	FWD/REV	FWD and REV keys enabled														
<u>Parameter Value</u>	<u>Description</u>																					
Forward	Forward Only, REV key disabled																					
FWD/REV	FWD and REV keys enabled																					
203 Stop Key Remote	Default = Coast	Range: n/a Level: 2																				
Parameter <b>203</b> , the <b>Stop Key Remote</b> parameter, configures how the Stop key on the keypad will operate when the keypad is not the drive's control source (terminals, SIO, or SEQ).																						
The following data values may be assigned to this parameter:																						
<table border="0"> <thead> <tr> <th data-bbox="315 1572 477 1593"><u>Parameter Value</u></th> <th data-bbox="505 1572 610 1593"><u>Description</u></th> </tr> </thead> <tbody> <tr> <td data-bbox="315 1614 370 1635">Coast</td> <td data-bbox="505 1614 727 1635">Drive will coast to a stop</td> </tr> <tr> <td data-bbox="315 1646 370 1667">Ramp</td> <td data-bbox="505 1646 857 1667">Drive will ramp to a stop using Decel #1</td> </tr> <tr> <td data-bbox="315 1677 396 1698">Disabled</td> <td data-bbox="505 1677 773 1698">Stop key will have no function</td> </tr> </tbody> </table>			<u>Parameter Value</u>	<u>Description</u>	Coast	Drive will coast to a stop	Ramp	Drive will ramp to a stop using Decel #1	Disabled	Stop key will have no function												
<u>Parameter Value</u>	<u>Description</u>																					
Coast	Drive will coast to a stop																					
Ramp	Drive will ramp to a stop using Decel #1																					
Disabled	Stop key will have no function																					

**Table 7-2: Description of X4 Parameters** (Page 4 of 26)

204-Ref Select	Default = Vin1	Range: n/a Level: 2																														
<p>Parameter <b>204</b>, the <b>Ref Select</b> parameter, configures how the reference is determined when the reference source is configured to terminals.</p> <p>The following data values may be assigned to this parameter:</p> <table border="1" data-bbox="310 464 1063 871"> <thead> <tr> <th>Parameter Value</th> <th>Description</th> </tr> </thead> <tbody> <tr><td>Vin1</td><td>Vin1 terminal (configured by parameter 205)</td></tr> <tr><td>Cin</td><td>Cin terminal (configured by parameter 208)</td></tr> <tr><td>Vin2</td><td>Vin2 terminal (configured by parameter 211)</td></tr> <tr><td>Vin1 6FS</td><td>Vin1 terminal with 6x pulse train from an X4, WFC, WF2 drive</td></tr> <tr><td>Vin1 48FS</td><td>Vin1 terminal with 48x pulse train from an X4, WFC, WF2 drive</td></tr> <tr><td>Vin1+Cin</td><td>Sum of signal at Vin1 and the signal at Cin</td></tr> <tr><td>Vin1+Vin2</td><td>Sum of signal at Vin1 and the signal at Vin2</td></tr> <tr><td>Vin1-Cin</td><td>Difference between the signal at Vin and the signal at Cin</td></tr> <tr><td>Vin1-Vin2</td><td>Difference between the signal at Vin and the signal at Vin2</td></tr> <tr><td>Max Input<sup>(2)</sup></td><td>Greatest signal between Vin, Vin2 and Cin</td></tr> <tr><td>Vin1/Cin DI<sup>(1)</sup></td><td>Switch between Vin and Cin using a Digital Input</td></tr> <tr><td>Vin1/2 DI<sup>(1)</sup></td><td>Switch between Vin and Vin2 using a Digital Input</td></tr> <tr><td>Vin1/KYP DI<sup>(1)</sup></td><td>Switch between Vin and Keypad reference using Digital Input</td></tr> <tr><td>Cin/KYP DI<sup>(1)</sup></td><td>Switch between Cin and Keypad reference using Digital Input</td></tr> </tbody> </table> <p><b>Notes:</b></p> <ol style="list-style-type: none"> <li>The parameter that sets the function of the designated digital input must be configured as "Ref Switch" to complete the implementation.</li> <li>The "Max Input" option will compare the inputs of all three analog inputs (Vin1, Vin2, Cin) and take the analog input with the highest percentage input after span, offset, and inversion is applied.</li> <li>When using a 6FS signal, parameter <b>205</b> should be set to 0-10V.</li> </ol>			Parameter Value	Description	Vin1	Vin1 terminal (configured by parameter 205)	Cin	Cin terminal (configured by parameter 208)	Vin2	Vin2 terminal (configured by parameter 211)	Vin1 6FS	Vin1 terminal with 6x pulse train from an X4, WFC, WF2 drive	Vin1 48FS	Vin1 terminal with 48x pulse train from an X4, WFC, WF2 drive	Vin1+Cin	Sum of signal at Vin1 and the signal at Cin	Vin1+Vin2	Sum of signal at Vin1 and the signal at Vin2	Vin1-Cin	Difference between the signal at Vin and the signal at Cin	Vin1-Vin2	Difference between the signal at Vin and the signal at Vin2	Max Input <sup>(2)</sup>	Greatest signal between Vin, Vin2 and Cin	Vin1/Cin DI <sup>(1)</sup>	Switch between Vin and Cin using a Digital Input	Vin1/2 DI <sup>(1)</sup>	Switch between Vin and Vin2 using a Digital Input	Vin1/KYP DI <sup>(1)</sup>	Switch between Vin and Keypad reference using Digital Input	Cin/KYP DI <sup>(1)</sup>	Switch between Cin and Keypad reference using Digital Input
Parameter Value	Description																															
Vin1	Vin1 terminal (configured by parameter 205)																															
Cin	Cin terminal (configured by parameter 208)																															
Vin2	Vin2 terminal (configured by parameter 211)																															
Vin1 6FS	Vin1 terminal with 6x pulse train from an X4, WFC, WF2 drive																															
Vin1 48FS	Vin1 terminal with 48x pulse train from an X4, WFC, WF2 drive																															
Vin1+Cin	Sum of signal at Vin1 and the signal at Cin																															
Vin1+Vin2	Sum of signal at Vin1 and the signal at Vin2																															
Vin1-Cin	Difference between the signal at Vin and the signal at Cin																															
Vin1-Vin2	Difference between the signal at Vin and the signal at Vin2																															
Max Input <sup>(2)</sup>	Greatest signal between Vin, Vin2 and Cin																															
Vin1/Cin DI <sup>(1)</sup>	Switch between Vin and Cin using a Digital Input																															
Vin1/2 DI <sup>(1)</sup>	Switch between Vin and Vin2 using a Digital Input																															
Vin1/KYP DI <sup>(1)</sup>	Switch between Vin and Keypad reference using Digital Input																															
Cin/KYP DI <sup>(1)</sup>	Switch between Cin and Keypad reference using Digital Input																															
205 Vin1 Config	Default = 0-10V	Range: n/a Level: 2																														
<p>Parameter <b>205</b>, <b>Vin1 Config</b>, selects the type of signal for analog input Vin1. Vin1 can be voltage, current, or pulse train input. This parameter also determines input range, impedance, and characteristics. Use Parameters <b>206 (Vin1 Offset)</b> and <b>207 (Vin1 Span)</b> to customize the selected range. The following data values may be assigned to this parameter:</p> <table border="1" data-bbox="310 1192 1088 1600"> <thead> <tr> <th>Parameter Value</th> <th>Description</th> </tr> </thead> <tbody> <tr><td>0-10V</td><td>0-10Vdc signal</td></tr> <tr><td>0-10V Brk W</td><td>0-10Vdc signal with broken wire detection for speed pot operation</td></tr> <tr><td>0-10V I</td><td>0-10Vdc signal Inverted</td></tr> <tr><td>0-10V Bipol</td><td>0-10Vdc signal (5Vdc is stop with 0Vdc Full Rev and 10Vdc Full FWD)</td></tr> <tr><td>0-5V</td><td>0-5Vdc signal</td></tr> <tr><td>0-5V I</td><td>0-5Vdc signal Inverted</td></tr> <tr><td>0-20mA 250</td><td>0 to 20 mA current signal with 250 Ohm load</td></tr> <tr><td>0-20mA 250I</td><td>0 to 20 mA current signal with 250 Ohm load Inverted</td></tr> <tr><td>4-20mA 250</td><td>4 to 20 mA current signal with 250 Ohm load load</td></tr> <tr><td>4-20mA 250I</td><td>4 to 20 mA current signal with 250 Ohm load Inverted</td></tr> <tr><td>PT 0-1kHz</td><td>0 to 1 kHz pulse train</td></tr> <tr><td>PT 0-10kHz</td><td>0 to 10 kHz pulse train</td></tr> <tr><td>PT 0-100kHz</td><td>0 to 100 kHz pulse train</td></tr> </tbody> </table> <p>When the signal range is inverted (that is, the minimum input corresponds to the maximum output, while the maximum input corresponds to the minimum output).</p>			Parameter Value	Description	0-10V	0-10Vdc signal	0-10V Brk W	0-10Vdc signal with broken wire detection for speed pot operation	0-10V I	0-10Vdc signal Inverted	0-10V Bipol	0-10Vdc signal (5Vdc is stop with 0Vdc Full Rev and 10Vdc Full FWD)	0-5V	0-5Vdc signal	0-5V I	0-5Vdc signal Inverted	0-20mA 250	0 to 20 mA current signal with 250 Ohm load	0-20mA 250I	0 to 20 mA current signal with 250 Ohm load Inverted	4-20mA 250	4 to 20 mA current signal with 250 Ohm load load	4-20mA 250I	4 to 20 mA current signal with 250 Ohm load Inverted	PT 0-1kHz	0 to 1 kHz pulse train	PT 0-10kHz	0 to 10 kHz pulse train	PT 0-100kHz	0 to 100 kHz pulse train		
Parameter Value	Description																															
0-10V	0-10Vdc signal																															
0-10V Brk W	0-10Vdc signal with broken wire detection for speed pot operation																															
0-10V I	0-10Vdc signal Inverted																															
0-10V Bipol	0-10Vdc signal (5Vdc is stop with 0Vdc Full Rev and 10Vdc Full FWD)																															
0-5V	0-5Vdc signal																															
0-5V I	0-5Vdc signal Inverted																															
0-20mA 250	0 to 20 mA current signal with 250 Ohm load																															
0-20mA 250I	0 to 20 mA current signal with 250 Ohm load Inverted																															
4-20mA 250	4 to 20 mA current signal with 250 Ohm load load																															
4-20mA 250I	4 to 20 mA current signal with 250 Ohm load Inverted																															
PT 0-1kHz	0 to 1 kHz pulse train																															
PT 0-10kHz	0 to 10 kHz pulse train																															
PT 0-100kHz	0 to 100 kHz pulse train																															
206 Vin1 Offset	Default = 0.00%	Range: 0.0 to 100.0% Level: 2																														
<p>Parameter <b>206</b>, <b>Vin1 Offset</b>, configures the input range (offset) for analog input Vin1 that will affect speed or torque limit functions. It is expressed as a percentage of the maximum value of the input signal.</p> <p>Note that if the input signal drops below the offset value or if the input signal is lost (if no offset is configured), fault 22 will be generated.</p>																																

**Table 7-2: Description of X4 Parameters** (Page 5 of 26)

<b>207 Vin1 Span</b>	Default = 100%	Range: 10.0 to 200.0% Level: 2														
Parameter <b>207</b> , the <b>Vin1 Span</b> parameter, is used to alter the input range (span) of the input signal for analog input Vin1 that will affect speed or torque limit functions. For example, if parameter <b>205, Vin1 Config</b> , selects the 0 to 10 Vdc input signal, setting this parameter to 50% reduces it to 0 to 5 Vdc.																
<b>208-Cin Config</b>	Default = 0-20mA 50	Range: n/a Level 2														
Parameter <b>208, Cin Config</b> , selects the type of signal for analog input Cin. Parameters 209 (Cin Offset) and 210 (Cin Span) may be used to customize the selected range. The following data values may be assigned to this parameter:																
<table border="1"> <thead> <tr> <th>Parameter Value</th> <th>Description</th> </tr> </thead> <tbody> <tr> <td>4-20mA 50</td> <td>4 to 20 mA current signal with 50 Ohm load</td> </tr> <tr> <td>4-20mA 50I</td> <td>4 to 20 mA current signal with 50 Ohm load Inverted</td> </tr> <tr> <td>0-20mA 50</td> <td>0 to 20 mA current signal with 50 Ohm load load</td> </tr> <tr> <td>0-20mA 50I</td> <td>0 to 20 mA current signal with 50 Ohm load Inverted</td> </tr> </tbody> </table>			Parameter Value	Description	4-20mA 50	4 to 20 mA current signal with 50 Ohm load	4-20mA 50I	4 to 20 mA current signal with 50 Ohm load Inverted	0-20mA 50	0 to 20 mA current signal with 50 Ohm load load	0-20mA 50I	0 to 20 mA current signal with 50 Ohm load Inverted				
Parameter Value	Description															
4-20mA 50	4 to 20 mA current signal with 50 Ohm load															
4-20mA 50I	4 to 20 mA current signal with 50 Ohm load Inverted															
0-20mA 50	0 to 20 mA current signal with 50 Ohm load load															
0-20mA 50I	0 to 20 mA current signal with 50 Ohm load Inverted															
When the signal range is inverted (that is, the minimum input corresponds to the maximum output, while the maximum input corresponds to the minimum output).																
<b>209 Cin Offset</b>	Default = 0.0%	Range: 0.0% to 100.0% Level: 2														
Parameter <b>209, Cin Offset</b> , configures the offset for analog input Cin expressed as a percentage of the maximum value of the input signal. Note that if the input signal drops below the offset value or if the input signal is lost (if no offset is configured), a fault will be generated.																
<b>210 Cin Span</b>	Default = 100.0%	Range: 10.0% to 200.0%														
Parameter <b>210, Cin Span</b> , is used to alter the range of the input signal for analog input Cin. For example, if parameter <b>208 (Cin Config)</b> selects the 0 to 20 mA input signal, setting this parameter to 50% reduces it to 0 to 10 mA.																
<b>211 Vin2 Config</b>	Default = 0-10 V	Range: n/a Level: 2														
Parameter <b>211, Vin2 Config</b> , selects the type of signal for analog input Vin2. Parameters <b>212 (Vin2 Offset)</b> and <b>213 (Vin2 Span)</b> may be used to customize the selected range. The following data values may be assigned to this parameter:																
<table border="1"> <thead> <tr> <th>Parameter Value</th> <th>Description</th> </tr> </thead> <tbody> <tr> <td>0-10V</td> <td>0-10Vdc signal</td> </tr> <tr> <td>0-10V Brk W</td> <td>0-10Vdc signal with broken wire detection for speed pot operation</td> </tr> <tr> <td>0-10V I</td> <td>0-10Vdc signal inverted</td> </tr> <tr> <td>0-10V Bipol</td> <td>0-10Vdc signal (5Vdc is stop with 0Vdc Full REV and 10Vdc Full FWD)</td> </tr> <tr> <td>0-5V</td> <td>0-5Vdc signal</td> </tr> <tr> <td>0-5V I</td> <td>0-5Vdc signal inverted</td> </tr> </tbody> </table>			Parameter Value	Description	0-10V	0-10Vdc signal	0-10V Brk W	0-10Vdc signal with broken wire detection for speed pot operation	0-10V I	0-10Vdc signal inverted	0-10V Bipol	0-10Vdc signal (5Vdc is stop with 0Vdc Full REV and 10Vdc Full FWD)	0-5V	0-5Vdc signal	0-5V I	0-5Vdc signal inverted
Parameter Value	Description															
0-10V	0-10Vdc signal															
0-10V Brk W	0-10Vdc signal with broken wire detection for speed pot operation															
0-10V I	0-10Vdc signal inverted															
0-10V Bipol	0-10Vdc signal (5Vdc is stop with 0Vdc Full REV and 10Vdc Full FWD)															
0-5V	0-5Vdc signal															
0-5V I	0-5Vdc signal inverted															
<b>212 Vin2 Offset</b>	Default = 0.0%	Range: 0.0% to 100.0% Level: 2														
Parameter <b>212, Vin2 Offset</b> , configures the offset for analog input Vin2 expressed as a percentage of the maximum value of the input signal. Note that if the input signal drops below the offset value or if the input signal is lost (if no offset is configured), a fault will be generated.																
<b>213 Vin2 Span</b>	Default = 100%	Range: 10.0 to 200.0%														
Parameter <b>213, Vin2 Span</b> , is used to alter the range of the input signal for analog input Vin2. For example, if parameter <b>211 (Vin2 Config)</b> selects the 0 to 10Vdc input signal, setting this parameter to 50% reduces it to 0 to 5Vdc.																
<b>214 Vin1 Filter Time</b>	Default = 20 ms	Range: 0 to 1000 ms Level: 2														
This parameter configures the time constant of a filter for the Vin1 analog input. When the parameter value is set to 0 ms, there is no software filtering of the analog input. A value above 0 ms causes the drive to filter the analog signal. <b>Note that long filter times will create a delay in the drive response to signal changes.</b>																

**Table 7-2: Description of X4 Parameters** (Page 6 of 26)

<b>215 Cin Filter Time</b>	Default = 20 ms	Range: 0 to 1000 ms Level: 2
This parameter configures the time constant of a filter of the Cin analog input. When the parameter value is set to 0 ms, there is no software filtering of the analog input. A value above 0 ms causes the drive to filter the analog signal. <b>Note that long filter times will create a delay in the drive response to signal changes.</b>		
<b>216 Vin2 Filter Time</b>	Default = 20 ms	Range: 0 to 1000 ms Level: 2
This parameter configures the time constant of a filter for the Vin2 analog input. When the parameter value is set to 0 ms, there is no software filtering of the analog input. A value above 0 ms causes the drive to filter the analog signal. <b>Note that long filter times will create a delay in the drive response to signal changes.</b>		
<b>217 Trim Ref Enable</b>	Default = 0	Range: n/a Level: 2
This parameter enables or disables trimming of the drive reference by an analog input and selects which analog input will perform the trimming function. <b>Speed Reference = Main reference + (Trim % Factor) * value of Parameter 217 * Max Frequency / 100%</b> <u>Parameter Value</u> <u>Description</u> Disabled            No trimming of drive reference Vin1                 Value of Vin1 will be used in the calculation above Vin2                 Value of Vin2 will be used in the calculation above Cin                    Value of Cin will be used in the calculation above Fxd Trim %         Value of Fxd Trim % will be used <b>Drive Reference = Drive Reference + (Trim % Factor) * Max Frequency / 100%</b> Note that setting a parameter for a Bipolar input value allows trimming both positive and negative around the reference value.		
<b>218 Trim % Factor</b>	Default = 0.0%	Range: -100.0% to +100.0% Level 2
This parameter determines the percentage of the analog input signal selected in <b>Parameter 217, Trim Ref Enable</b> , that will affect the reference signal.		
<b>301 Min Frequency</b>	Default = 0.0%	Range: 0.0-Max Freq
Parameter <b>301, Minimum Frequency</b> , configures the minimum frequency output of the drive. This parameter governs the minimum frequency when operating from the keypad or from an analog input. The preset speeds can be set lower than the minimum frequency in parameter 301.		
<b>302 Max Frequency</b>	Default: 60 Hz	Range: 0.0 to 400.0 Hz
Parameter <b>302, the Maximum Frequency</b> parameter, configures the maximum frequency output of the drive.		
<b>303 Preset Freq 1 (Jog Ref)</b> <b>304 Preset Freq 2</b> <b>305 Preset Freq 3</b> <b>306 Preset Freq 4</b> <b>307 Preset Freq 5</b> <b>308 Preset Freq 6</b>	Default: 5 Hz Default: 10 Hz Default: 20 Hz Default: 30 Hz Default: 40 Hz Default: 50 Hz	Range: 0.0-Max Freq Levels 1,2 for 303 Level 2 for 304-308
These parameters configure six preset speeds in addition to the normal reference speed of the drive (as defined by parameters <b>201 (Input Mode)</b> and <b>204 (Ref Select)</b> ) and the maximum frequency of the drive (as set with parameter <b>302, Max Frequency</b> ). Thus, in effect, you may choose to operate the drive at up to eight different speeds. The eight speeds are selected by a combination of three digital inputs (PS1, PS2, PS3). A wiring scheme for utilizing preset speeds is provided on page 28 along with a truth table showing what combination of inputs results in the selection of which speeds. Note that parameter <b>Parameter 303 (Preset Freq1)</b> also serves as the reference frequency for jogging.		

**Table 7-2: Description of X4 Parameters** (Page 7 of 26)

<b>309 Cut-Off Freq</b>	Default: 0.0 Hz	Range: 0.0 to 5.0 Hz Level 2																																	
<p>This parameter sets the point where the drive no longer attempts to spin the motor. The range of this parameter is 0.0-5.0 Hz. When the parameter is configured to a value of 0.0 Hz, the drive will operate with no Cut-off Frequency. If the function is enabled, the drive will be able to ramp up through the cut-off frequency range, as in normal operation. If the speed command falls below the cut-off frequency, the drive stops "gating" the outputs and coasts down to zero speed. The keypad display will indicate Zero Speed, and the Forward or Reverse LED will be lit depending on the command. When the reference returns to a value greater than the cut-off frequency, the drive will ramp from 0.0 Hz to the reference frequency.</p>																																			
<b>401 Ramp Select</b>	Default: ART DI	Range: n/a Level: 2																																	
<p>The <b>Ramp Select</b> parameter configures when the alternate ramps of the drive will be active and whether the drive ramps to stop, or coasts to stop. The following data values may be assigned to this parameter:</p> <table border="1"> <thead> <tr> <th>Parameter Value</th> <th>Type of Ramp</th> <th>Ramp Configured by:</th> </tr> </thead> <tbody> <tr> <td>ART-DI</td> <td>Ramp-to-Stop</td> <td><b>402 (Accel Time 1)</b> and <b>403 (Decel Time 1)</b></td> </tr> <tr> <td>ART-F/R</td> <td>Ramp-to-Stop</td> <td>Running forward: <b>402 (Accel Time 1)</b> and <b>403 (Decel Time 1)</b> Running reverse: <b>404 (Accel Time 2)</b> and <b>405 (Decel Time 2)</b></td> </tr> <tr> <td>ART-Frq</td> <td>Ramp-to-Stop</td> <td>If the output frequency is less than preset frequency parameter <b>308 (Preset Freq 6)</b>, the active ramp is set by <b>402 Accel Time 1</b> and <b>403 Decel Time 1</b>. If the output frequency is equal to or greater than <b>308 (Preset Freq 6)</b>, the active ramp is set by <b>404 (Accel Time 2)</b> and <b>405 (Decel Time 2)</b>.</td> </tr> <tr> <td>ART-Strt/RS</td> <td>Ramp-to-Stop</td> <td>This setting uses the Alternate Ramp for Acceleration (parameter 404) to the set speed, then uses the Main ramps (parameters 402 and 403) when the speeds are adjusted. The drive will revert to the Alternate Decel ramp (parameter 405) when a Stop command is given.</td> </tr> <tr> <td>S-Curve</td> <td>Ramp-to-Stop</td> <td>The drive uses <b>402 (Accel Time 1)</b> and <b>403 (Decel Time 1)</b> for total time and <b>414</b> as the S Ramp Rounding value. The amount of rounding is the same for that start and stop of the ramp time.</td> </tr> <tr> <td>ART-DI CTS</td> <td>Coast-to-Stop</td> <td>Same as ART-DI but with Coast-to-Stop</td> </tr> <tr> <td>ART-F/R CTS</td> <td>Coast-to-Stop</td> <td>Same as ART-F/R but with Coast-to-Stop</td> </tr> <tr> <td>ART-Frq CTS</td> <td>Coast-to-Stop</td> <td>Same as ART-Frq but with Coast-to-Stop</td> </tr> <tr> <td>ART-Str/CS</td> <td>Coast-to-Stop</td> <td>Same as ART-Strt but with Coast-to-Stop</td> </tr> <tr> <td>S-Curve CTS</td> <td>Coast-to-Stop</td> <td>Same as S-Curve but with Coast-to-Stop</td> </tr> </tbody> </table>			Parameter Value	Type of Ramp	Ramp Configured by:	ART-DI	Ramp-to-Stop	<b>402 (Accel Time 1)</b> and <b>403 (Decel Time 1)</b>	ART-F/R	Ramp-to-Stop	Running forward: <b>402 (Accel Time 1)</b> and <b>403 (Decel Time 1)</b> Running reverse: <b>404 (Accel Time 2)</b> and <b>405 (Decel Time 2)</b>	ART-Frq	Ramp-to-Stop	If the output frequency is less than preset frequency parameter <b>308 (Preset Freq 6)</b> , the active ramp is set by <b>402 Accel Time 1</b> and <b>403 Decel Time 1</b> . If the output frequency is equal to or greater than <b>308 (Preset Freq 6)</b> , the active ramp is set by <b>404 (Accel Time 2)</b> and <b>405 (Decel Time 2)</b> .	ART-Strt/RS	Ramp-to-Stop	This setting uses the Alternate Ramp for Acceleration (parameter 404) to the set speed, then uses the Main ramps (parameters 402 and 403) when the speeds are adjusted. The drive will revert to the Alternate Decel ramp (parameter 405) when a Stop command is given.	S-Curve	Ramp-to-Stop	The drive uses <b>402 (Accel Time 1)</b> and <b>403 (Decel Time 1)</b> for total time and <b>414</b> as the S Ramp Rounding value. The amount of rounding is the same for that start and stop of the ramp time.	ART-DI CTS	Coast-to-Stop	Same as ART-DI but with Coast-to-Stop	ART-F/R CTS	Coast-to-Stop	Same as ART-F/R but with Coast-to-Stop	ART-Frq CTS	Coast-to-Stop	Same as ART-Frq but with Coast-to-Stop	ART-Str/CS	Coast-to-Stop	Same as ART-Strt but with Coast-to-Stop	S-Curve CTS	Coast-to-Stop	Same as S-Curve but with Coast-to-Stop
Parameter Value	Type of Ramp	Ramp Configured by:																																	
ART-DI	Ramp-to-Stop	<b>402 (Accel Time 1)</b> and <b>403 (Decel Time 1)</b>																																	
ART-F/R	Ramp-to-Stop	Running forward: <b>402 (Accel Time 1)</b> and <b>403 (Decel Time 1)</b> Running reverse: <b>404 (Accel Time 2)</b> and <b>405 (Decel Time 2)</b>																																	
ART-Frq	Ramp-to-Stop	If the output frequency is less than preset frequency parameter <b>308 (Preset Freq 6)</b> , the active ramp is set by <b>402 Accel Time 1</b> and <b>403 Decel Time 1</b> . If the output frequency is equal to or greater than <b>308 (Preset Freq 6)</b> , the active ramp is set by <b>404 (Accel Time 2)</b> and <b>405 (Decel Time 2)</b> .																																	
ART-Strt/RS	Ramp-to-Stop	This setting uses the Alternate Ramp for Acceleration (parameter 404) to the set speed, then uses the Main ramps (parameters 402 and 403) when the speeds are adjusted. The drive will revert to the Alternate Decel ramp (parameter 405) when a Stop command is given.																																	
S-Curve	Ramp-to-Stop	The drive uses <b>402 (Accel Time 1)</b> and <b>403 (Decel Time 1)</b> for total time and <b>414</b> as the S Ramp Rounding value. The amount of rounding is the same for that start and stop of the ramp time.																																	
ART-DI CTS	Coast-to-Stop	Same as ART-DI but with Coast-to-Stop																																	
ART-F/R CTS	Coast-to-Stop	Same as ART-F/R but with Coast-to-Stop																																	
ART-Frq CTS	Coast-to-Stop	Same as ART-Frq but with Coast-to-Stop																																	
ART-Str/CS	Coast-to-Stop	Same as ART-Strt but with Coast-to-Stop																																	
S-Curve CTS	Coast-to-Stop	Same as S-Curve but with Coast-to-Stop																																	
<b>402 Accel Time 1</b>	Default: 5.0 s	Range: 0.1 to 3200.0 s Levels 1,2																																	
<p>This parameter configures the default length of time to accelerate from 0 Hz to the value of parameter <b>302 (Max Frequency)</b>. This acceleration ramp is selected by parameter <b>401 (Ramp Select)</b>. Note that extremely short acceleration times may result in nuisance fault trips.</p>																																			
<b>403 Decel Time 1</b>	Default: 5.0 s	Range: 0.1 to 3200.0 s Levels 1,2																																	
<p>This parameter configures the default length of time to decelerate from the value of parameter <b>302 (Max Frequency)</b> to 0 Hz. The deceleration ramp is selected by Parameter <b>401 (Ramp Select)</b>. Note that extremely short deceleration times may result in nuisance fault trips or may require an external dynamic brake or regen current limit.</p>																																			
<b>404 Accel Time 2</b>	Default: 3.0 s	Range: 0.1 to 3200.0 s Level 2																																	
<p>This parameter provides an alternate ramping time for the drive when accelerating, configuring the length of time to accelerate from 0 Hz to the value of parameter <b>302 (Max Frequency)</b>. This acceleration ramp is selected by parameter <b>401 (Ramp Select)</b> or Sequencer Configuration. Note that extremely short acceleration times may result in nuisance fault trips.</p>																																			



**Table 7-2: Description of X4 Parameters** (Page 8 of 26)

<b>405 Decel Time 2</b>	Default: 3.0 s	Range: 0.1 to 3200.0 s Level 2
<p>This parameter provides an alternate ramping time for the drive when decelerating, configuring the length of time to decelerate from the value of parameter <b>302 (Max Frequency)</b> to 0 Hz. This deceleration ramp is selected by parameter <b>401 (Ramp Select)</b> or Sequencer Configuration.</p> <p>Note that extremely short deceleration times may result in nuisance fault trips or may require an external dynamic brake or regen current limit.</p>		
<b>406 DC Inject Config</b>	Default: DC at Stop	Range: n/a Level 2
<p>DC injection braking may be used to stop the motor more quickly than is possible by either a ramp-to-stop or a coast-to-stop. The X4 drive allows DC braking to be initiated either when a digital input assigned to DC braking becomes true, when a specified frequency is reached, or when either of these events occurs.</p> <p>When using a digital input for DC braking, you must use one of the DI parameters to configure the selected digital input for DC braking. The amount of braking force is set by parameter <b>408 (DC Inject Level)</b>. The length of time that the braking force is applied is determined by the time that the selected digital input is active. The second type of DC injection braking supported by the X4 drive is where DC braking occurs at a specified frequency. The duration of the braking is adjusted by parameter <b>407 (DC Inject Time)</b>.</p> <p>With this type of braking, as the drive slows down after a Stop command, DC braking begins when the frequency reaches the value set in parameter <b>409 (DC Inj Freq)</b>. If the frequency at the time of a Stop command is less than that of <b>DC Inj Freq</b>, DC braking begins immediately. The braking continues for the time period specified by parameter <b>DC Inj Freq</b>. Once the time period elapses, the drive may be restarted.</p> <p><u>Parameter Value</u>    <u>Description</u></p> <p>DC at Stop            DC inject only on Stop</p> <p>DC at Start            DC inject only on Start</p> <p>DC at Both            DC inject only on both Start and Stop</p> <p>DC on Freq            DC inject only on Stop below the set frequency</p>		
<b>407 DC Inject Time</b>	Default: 0.2 sec	Range: 0.0 to 5.0 sec Level 2
<p>If parameter <b>406</b> is set to DC at Stop (see page 57), direct current is applied to the motor. This parameter, <b>DC Inject Time</b>, determines how long the direct current will be applied, and how long DC is applied at Start if programmed accordingly.</p> <p>This parameter works in tandem with parameter <b>410 (DC Inject Config)</b> and the other parameters associated with DC Inject Config. That is, the time period configured by this parameter, <b>DC Inject Time</b>, determines how long DC injection braking will be active. When DC injection braking is controlled by a digital input, the braking continues for as long as the digital input is true, <b>plus</b> the time set by parameter <b>407 (DC Inject Time)</b>. When it is controlled by frequency, however, it continues for the length of time once the drive reaches the frequency set by parameter <b>409 (DC Inj Freq)</b>.</p>		
<b>408 DC Inject Level</b>	Default: 50.0%	Range: 0.0% to 100.0% Level 2
<p>Configures the amount of DC injection that will occur when direct current is injected into the motor windings, which acts as a braking force. The amount of current is expressed as a percentage of nominal motor current. The braking force may be applied when starting or stopping. If this parameter is set to 0.0%, the DC injection is disabled.</p>		
<b>409 DC Inj Freq</b>	Default: 0 Hz	Range: 0.0 to 20.0 Hz Level 2
<p>Configures the frequency under which direct current will be applied to the drive when <b>DC Inject Config</b> is set to "DC on Freq." If this parameter is set to 0.0, the parameter operates in the same way as "DC at Stop."</p>		

**Table 7-2: Description of X4 Parameters** (Page 9 of 26)

<b>410 DB Config</b>	Default: DB Internal	Range: 0-2 Level 2										
<p>Determines whether an external or internal dynamic brake is utilized or disabled. The drive provides an internal dynamic brake (DB) to assist in stopping. If desired, an external resistor can be connected to DB and B+ for additional capacity. <b>(Note:</b> Size 0 models cannot have an external brake added.)</p> <p>The following data values may be assigned to this parameter:</p> <table border="1"> <thead> <tr> <th>Parameter Value</th> <th>Description</th> </tr> </thead> <tbody> <tr> <td>DB Internal</td> <td>Internal dynamic braking active</td> </tr> <tr> <td>DB External</td> <td>External dynamic braking active</td> </tr> <tr> <td>No Dyn Brk</td> <td>Dynamic braking circuit disabled</td> </tr> <tr> <td>Int-ARCTIC</td> <td>When DB Config is configured to "Int-ARCTIC," dynamic braking becomes active if the drive temperature drops below -7 degrees C. When the DB becomes active, an "ARCTIC Mode" warning flashes on the keypad. If the drive drops below -10 degrees C, the drive will be disabled and not allowed to run. The keypad will indicate a "Not enabled" state at this point. If the drive heats up after being below -10 degrees C, the drive must meet the following criteria before operating again: <ul style="list-style-type: none"> <li>a) Drive temperature must be above -9 degrees C, and</li> <li>b) Drive temperature must stay above -9 degrees C until a time period has elapsed. The time period is dependent on how far below -10 degrees C the drive was. Each degree below -10 degrees C adds another 4 minutes before restart.</li> </ul> </td> </tr> </tbody> </table>			Parameter Value	Description	DB Internal	Internal dynamic braking active	DB External	External dynamic braking active	No Dyn Brk	Dynamic braking circuit disabled	Int-ARCTIC	When DB Config is configured to "Int-ARCTIC," dynamic braking becomes active if the drive temperature drops below -7 degrees C. When the DB becomes active, an "ARCTIC Mode" warning flashes on the keypad. If the drive drops below -10 degrees C, the drive will be disabled and not allowed to run. The keypad will indicate a "Not enabled" state at this point. If the drive heats up after being below -10 degrees C, the drive must meet the following criteria before operating again: <ul style="list-style-type: none"> <li>a) Drive temperature must be above -9 degrees C, and</li> <li>b) Drive temperature must stay above -9 degrees C until a time period has elapsed. The time period is dependent on how far below -10 degrees C the drive was. Each degree below -10 degrees C adds another 4 minutes before restart.</li> </ul>
Parameter Value	Description											
DB Internal	Internal dynamic braking active											
DB External	External dynamic braking active											
No Dyn Brk	Dynamic braking circuit disabled											
Int-ARCTIC	When DB Config is configured to "Int-ARCTIC," dynamic braking becomes active if the drive temperature drops below -7 degrees C. When the DB becomes active, an "ARCTIC Mode" warning flashes on the keypad. If the drive drops below -10 degrees C, the drive will be disabled and not allowed to run. The keypad will indicate a "Not enabled" state at this point. If the drive heats up after being below -10 degrees C, the drive must meet the following criteria before operating again: <ul style="list-style-type: none"> <li>a) Drive temperature must be above -9 degrees C, and</li> <li>b) Drive temperature must stay above -9 degrees C until a time period has elapsed. The time period is dependent on how far below -10 degrees C the drive was. Each degree below -10 degrees C adds another 4 minutes before restart.</li> </ul>											
<b>⚠ CAUTION</b>												
<b>MOTOR OVERHEATING</b>												
Do not use DC injection braking as a holding brake, or excessive motor heating may result.												
<b>Failure to observe this instruction can result in equipment damage.</b>												
<b>⚠ ATTENTION</b>												
<b>SURCHAUFFE DU MOTEUR</b>												
N'utilisez pas le freinage CC comme frein de maintien car cela peut entraîner une surchauffe excessive du moteur.												
<b>Si cette directive n'est pas respectée, cela peut entraîner des dommages matériels.</b>												
<b>414 S Ramp Rounding</b>	Default: 25%	Range: 1-100% Level 2										
<p>This parameter is used to define the amount of rounding or S-curve to the Accel and Decel ramp. The amount of rounding is split evenly between the beginning and the end of the ramp. A value of 1% would mean that the rounding of the ramp is near linear. A value of 50% would have 25% rounding at the start of the ramp and 25% at the end of the ramp.</p>												

**Table 7-2: Description of X4 Parameters** (Page 10 of 26)

<b>501 V/Hz Select</b>	Default: Linear Fxd	Range: 0 to 7 Level 2														
<p>The <b>V/Hz Characteristic Selection</b> parameter determines the characteristic of the V/Hz curve and whether any boost will be applied at starting. The following data values may be assigned:</p> <table border="1"> <thead> <tr> <th>Parameter Value</th> <th>Description</th> </tr> </thead> <tbody> <tr> <td>Linear Auto</td> <td>The Linear Auto selection operates the Vector algorithm and activates current limiting functionality.</td> </tr> <tr> <td>Linear Fxd</td> <td>V/Hz curve with the amount of boost fixed at the value set in parameter <b>502 (Voltage Boost)</b>.</td> </tr> <tr> <td>Pump Fxd</td> <td>V/Hz curve with the amount of boost fixed at the value set in parameter <b>502 (Voltage Boost)</b>.</td> </tr> <tr> <td>Fan Fxd</td> <td>V/Hz curve with the amount of boost fixed at the value set in parameter <b>502 (Voltage Boost)</b>.</td> </tr> <tr> <td>Linear 2pc</td> <td>Activates parameters <b>512 (Midpoint Frq)</b> and <b>513 (Midpoint Volt)</b>. These parameters are used to define a midpoint through which the V/Hz curve passes so a custom curve may be created for special motor applications.</td> </tr> <tr> <td>Vector</td> <td>Activates the sensorless vector algorithm for high torque / low speed operation. A vector-duty motor should be used for this mode of operation. Vector mode does not use either of the boost parameters (parameter <b>502</b>)</td> </tr> </tbody> </table>			Parameter Value	Description	Linear Auto	The Linear Auto selection operates the Vector algorithm and activates current limiting functionality.	Linear Fxd	V/Hz curve with the amount of boost fixed at the value set in parameter <b>502 (Voltage Boost)</b> .	Pump Fxd	V/Hz curve with the amount of boost fixed at the value set in parameter <b>502 (Voltage Boost)</b> .	Fan Fxd	V/Hz curve with the amount of boost fixed at the value set in parameter <b>502 (Voltage Boost)</b> .	Linear 2pc	Activates parameters <b>512 (Midpoint Frq)</b> and <b>513 (Midpoint Volt)</b> . These parameters are used to define a midpoint through which the V/Hz curve passes so a custom curve may be created for special motor applications.	Vector	Activates the sensorless vector algorithm for high torque / low speed operation. A vector-duty motor should be used for this mode of operation. Vector mode does not use either of the boost parameters (parameter <b>502</b> )
Parameter Value	Description															
Linear Auto	The Linear Auto selection operates the Vector algorithm and activates current limiting functionality.															
Linear Fxd	V/Hz curve with the amount of boost fixed at the value set in parameter <b>502 (Voltage Boost)</b> .															
Pump Fxd	V/Hz curve with the amount of boost fixed at the value set in parameter <b>502 (Voltage Boost)</b> .															
Fan Fxd	V/Hz curve with the amount of boost fixed at the value set in parameter <b>502 (Voltage Boost)</b> .															
Linear 2pc	Activates parameters <b>512 (Midpoint Frq)</b> and <b>513 (Midpoint Volt)</b> . These parameters are used to define a midpoint through which the V/Hz curve passes so a custom curve may be created for special motor applications.															
Vector	Activates the sensorless vector algorithm for high torque / low speed operation. A vector-duty motor should be used for this mode of operation. Vector mode does not use either of the boost parameters (parameter <b>502</b> )															
<b>502 Voltage Boost</b>	Default: 1.0%	Range: 0.0 to 50.0% Levels 1,2														
<p>Parameter <b>502, Voltage Boost</b>, increases the motor voltage at low speed to increase the starting torque of the motor. The parameter sets the amount of boost (expressed as a percentage of the default boost) to be applied at zero frequency. The amount of boost decreases linearly with increasing speed.</p> <p>This parameter is used when parameter <b>501</b> is set with <b>fixed boost</b> options.</p> <p><b>Note:</b> In "Linear Fixed," "Pump Fxd," "Fan Fixed," and "Linear 2pc" options will have all Current Limiting and Torque Limiting disabled.</p>																
<b>⚠ CAUTION</b>																
<b>MOTOR OVERHEATING</b>																
Too much boost may cause excessive motor currents and motor overheating. Use only as much boost as is necessary to start the motor.																
<b>Failure to observe this instruction can result in equipment damage.</b>																
<b>⚠ ATTENTION</b>																
<b>SURCHAUFFE DU MOTEUR</b>																
Une amplification de puissance excessive peut entraîner des surintensités de courant et faire la surchauffe du moteur. N'utilisez que le niveau d'amplification nécessaire pour démarrer le moteur.																
<b>Si cette directive n'est pas respectée, cela peut entraîner des dommages matériels.</b>																
<b>503 V/Hz Knee Freq</b>	Default: 60 Hz	Range: 25 to 400 Hz Level 2														
<p>This parameter sets the point on the frequency scale of the V/Hz curve at which the output is at full line voltage. Normally, this is set at the base frequency of the motor, but it may be increased to enlarge the constant torque range on special motors. Setting this parameter to a higher value can reduce motor losses at low frequencies.</p>																

**Table 7-2: Description of X4 Parameters** (Page 11 of 26)

<b>504 Skip Freq Band</b>	Default: 0.2 Hz	Range: 0.2 to 20.0 Hz Level 2
<p>To reduce mechanical resonances in a drive system, the drive may be configured to “skip” certain frequencies. Once configured, the drive will accelerate or decelerate through the prohibited frequency band without settling on any frequency in the band.</p> <p>The X4 AC drive provides the capability to configure four prohibited frequency bands. Parameter <b>504 (Skip Freq Band)</b>, the Skip Frequency Band parameter, sets the width of the band above and below each of the prohibited frequencies set in parameters <b>505, 506, 507, and 508 (Skip Freq 1,2,3, 4)</b>.</p> <p>For example, if this parameter is set to its default value of 1 Hz and parameter <b>505 (Skip Freq 1)</b> is set to 20 Hz, a skip band from 19 to 21 Hz is established.</p>		
<b>505 Skip Freq 1 506 Skip Freq 2 507 Skip Freq 3 508 Skip Freq 4</b>	Default: 0.0 Hz	Range: Min Freq-Max Freq Level 2
<p>As discussed in the description of parameter <b>504 (Skip Freq Band)</b>, the drive may be configured to skip certain frequencies. These three parameters set the center of the three skip frequency bands (with the width of each band being twice the value of parameter <b>504</b> — an equal amount above and below the skip frequency).</p> <p>For example, if parameter <b>504</b> is set to 2.5 Hz and parameter <b>508 (Skip Freq 4)</b> is set to 55 Hz, a skip band from 52.5 to 57.5 Hz is established.</p>		
<b>509 Rated Mtr Volt</b>	Default: Model dependent	Range: 100 V - 690 V Level 2, Macro
<p>The Rated Motor Voltage parameter configures the rated motor voltage, and allows a user to enter the rated voltage from the motor nameplate to provide optimal control and protection. This is usually the amount of voltage delivered to the motor terminals at the setting of <b>503 (V/Hz Knee Freq)</b>.</p>		
<b>510 Rated Mtr FLA</b>	Default: ND Rating	Range: 50% - 200% of ND rating Level 2, Macro
<p>The Rated Motor FLA parameter allows a user to enter the rated FLA from the motor nameplate to provide optimal control and protection. This parameter should be configured to the value on the nameplate of the motor, as that value is used in calculating the percentage of current at which the drive is operating.</p> <p>For information on motor timed overload operation, and how Parameter 510 works with it, see page 64.</p>		
<b>511 Rated Mtr RPM</b>	Default: 1750 rpm	Range: 0-24000 rpm Level 2, Macro
<p>This parameter replaces the slip compensation parameter setting of the drive so the user does not need to calculate it.</p>		
<b>512 Midpoint Freq</b>	Default: 60.0 Hz	Range: 0.0 Hz-V/Hz Knee Freq Level 2
<p>When parameter <b>501, V/Hz Select</b>, is configured to “Linear 2pc,” this parameter, together with parameter <b>513, Midpoint Volt</b>, defines an additional point in the V/Hz characteristic.</p>		
<b>513 Midpoint Volt</b>	Default: 100.0%	Range: 0.0%-100.0% Level 2
<p>When parameter <b>501, V/Hz Select</b>, is configured to “Linear 2pc,” this parameter, along with parameter <b>512, Midpoint Freq</b>, defines an additional point in the V/Hz characteristic.</p>		
<b>514 Motor RS</b>	Default: Model dependent	Range: 0.00-655.35 Ohms Level 2, Macro
<p>This parameter allows direct entry of the Stator Resistance (Rs) of the motor for better vector performance. The motor manufacturer can provide this information.</p>		
<b>515 Power Factor</b>	Default: 0.80	Range: 0.50 - 1.00 Level 2, Macro
<p>This parameter allows direct entry of the motor's power factor for better vector performance. The motor manufacturer can provide this information.</p>		

**Table 7-2: Description of X4 Parameters** (Page 12 of 26)

<b>516 Slip Comp Enable</b>	Default: No	Range: n/a Level 1,2
The following data values may be assigned to this parameter:		
<u>Parameter Value</u>	<u>Description</u>	
No	No Slip Compensation enabled	
Yes	Slip Compensation enabled	
Parameter <b>516</b> permits activation of slip compensation for better speed regulation. The motor rated speed must be entered into parameter <b>511 (Rated Mtr RPM)</b> for best results.		
<b>517 Single Phase</b>	Default: No	Range: n/a Level 2
The following data values may be assigned to this parameter:		
<u>Parameter Value</u>	<u>Description</u>	
No	No single phase input operation. Phase loss engaged.	
Yes	Single phase operation. No phase loss.	
<b>519 Find Mtr Data</b>	Default: Not active	Range: n/a Macro
This parameter activates the drive's ability to measure the stator resistance of the attached motor. The automatic stator resistance measurement can be performed either through the keypad or through the serial link. See "Measuring Stator Resistance (RS Measurement)" on page 37 for more information about this parameter. The following data values may be assigned:		
<u>Parameter Value</u>	<u>Description</u>	
Not Active	No stator RS measurement.	
Motor RS	Automatic RS measurement using macro procedure.	
<b>520 Filter FStator</b>	Default: 8 ms	Range: 1 - 100 ms Level 2
This parameter filters the stator frequency applied to the motor, which can help tune the acceleration behavior of the motor. This is particularly helpful when using short ramps and operating the motor at a frequency above the "V/Hz Knee Freq" ( <b>parameter 503</b> ) value (field weakening area). Lower values allow dynamic currents to be produced, but with greater peaks. This could produce unstable states in the field weakening area. Low values for this parameter can cause overcurrent faults while accelerating to frequencies over the Knee Frequency. Higher values allow the drive to run more smoothly at frequencies over the Knee Frequency and protect the drive against overcurrents--often the case when using special motors or spindle drives.		
<b>521 Start Field En</b>	Default: No	Range: n/a Level 2
<u>Parameter Value</u>	<u>Description</u>	
No	The shaft will begin rotating after receiving a Start command, without delay. If the application has heavy load conditions or short ramp times, this setting can produce very large starting currents, to overcome the inertia of the system. This may produce nuisance trips when starting.	
Yes	The shaft will begin rotating after receiving a Start command, with delay. During this delay, the drive is building up the magnetic field in the motor. This allows the drive to start in vector mode with less starting current.	
<b>522 Filter Time Slip</b>	Default: 100 ms	Range: 10 - 1000 ms Level 2
This parameter filters the slip frequency applied to the motor, which can help improve the dynamic response of the drive. This parameter produces the following results based on the parameter value:		
If the parameter is configured to <b>100 ms</b> , the drive will produce stable conditions to a change in load, in most cases.		
If the parameter is configured to <b>less than 100 ms</b> , the drive will be able to react quickly to a change in load, but may over-compensate its reaction to the load.		
If the parameter is configured to <b>greater than 100 ms</b> , the drive will react very slowly to a change in load and will need a longer time to compensate for the difference between the setpoint and the actual frequency.		

**Table 7-2: Description of X4 Parameters** (Page 13 of 26)

<b>523 Id Percent</b>	Default: Read-only	Range: 0 - 200% Level 2
This parameter shows the Flux producing current (as a percentage of motor rated current) that is being applied to the drive.		
<b>524 Iq Percent</b>	Default: Read-only	Range: 0 - 200% Level 2
This parameter shows the Torque producing current (as a percentage of motor rated current) that is being applied to the drive.		
<b>525 Power Fail Config</b>	Default: CTS No Msg	Range: n/a Level 2
This parameter can be used to define how the drive responds to an undervoltage operation when parameter 502 is set for Vector or Linear Auto mode. The following data values may be assigned to this parameter:		
<u>Parameter Value</u> <u>Description</u>		
CTS No Msg        The drive will coast to a stop when an undervoltage condition (power-down) is detected.		
Coast Stop        The drive will coast to a stop when an undervoltage condition (power-down) is detected. In this mode, however, the drive will generate an undervoltage fault, which will be registered in the fault log.		
Ramp Down        With this setting, if power is lost, the drive ramps the motor down at a decel rate of <b>Decel 1</b> . When the drive is fully ramped down, the drive will generate an undervoltage fault. If power is restored, the drive will continue to ramp to a stop and will fault.		
Quick Ramp        Same as Ramp Down, except the <b>shorter</b> ramp time (Decel 1 or Decel 2) will be used.		
Controlled        With this setting, if power is lost, the drive decelerates the motor, trying to regulate the bus voltage to the undervoltage level. If power is restored, the drive accelerates to the command frequency without faulting. If the drive reaches the stopped condition, it will generate an undervoltage fault.		
ContrNoMsg        Same as Controlled, but without generating an undervoltage fault.		
<b>Note:</b> Current limit is only available when Parameter <b>502</b> is set to Linear Auto. If Parameter <b>502</b> is set to Vector, then the Current Limiting values will actually be Torque Limiting values.		
<b>526 UV Ride-Thru En</b>	Default: w/ LVT	Range: n/a Level 2
This parameter allows the function to disable either (a) undervoltage ride-through or (b) continuous Line Voltage Tracking (LVT) that produces dynamic Undervoltage Ride-Thru Thresholds. The following data values may be assigned to this parameter:		
<u>Parameter Value</u> <u>Description</u>		
Disabled        This turns off the Undervoltage Ride-Thru function.		
w/ LVT        This enables the standard Ride-Thru algorithm in the V/Hz modes and allows the choice of algorithm in the Linear Auto and Vector modes.		
w/o LVT        This option operates in the same way as "w/ LVT" except that the Line Voltage Tracker function of the Undervoltage Ride-Thru is not active. The Line Voltage will be estimated on powering up the drive.		

**Table 7-2: Description of X4 Parameters** (Page 14 of 26)

<b>600 Current Lim Sel</b>	Default: Fixed Lvl's	Range: n/a Level 2
<p>The X4 drive provides a Current Limit feature. With this feature enabled, the drive's frequency is automatically reduced when operating in motoring mode to keep the measured torque within limits. When operating in regenerative mode, the output frequency can be automatically increased for the same reason. In addition to the current limit parameters that activate the Current Limit mode, more current limit parameters are available to adjust the drive's response to the load demands. The following data values may be assigned to this parameter:</p> <p><u>Parameter Value</u>    <u>Description</u></p> <p>Fixed Lvl's            The fixed levels set in parameters 601, 602, 603 and 604 determine the current limit in each of the four quadrants of operation.</p> <p>Vin2                    Vin2 analog input sets the current limit value, range 0-200%</p> <p>Cin                     Cin analog input sets the current limit value, range 0-200%</p> <p>Vin2 Motor            Vin2 analog input sets the motoring current limit value, range 0-200%</p> <p>Cin Motor             Cin analog input sets the motoring current limit value, range 0-200%</p> <p>Vin2 F-Mtr            Vin2 analog input sets the FWD motoring current limit value, range 0-200%</p> <p>Cin F-Motor            Cin analog input sets the FWD motoring current limit value, range 0-200%</p> <p><b>Note:</b> Current limit is only available when Parameter <b>502</b> is set to Linear Auto. If Parameter <b>502</b> is set to Vector, then the Current Limiting values will actually be Torque Limiting values.</p>		
<b>601 Cur Lim Mtr Fwd</b>	Default: 120%	Range: 5-150% Level 2
<p>This parameter sets the current limiting point when the drive is in motoring mode in the forward direction. The limit is expressed as a percentage of the current capacity of the drive.</p>		
<b>602 Cur Lim Mtr Rev</b>	Default: 120%	Range: 5-150% Level 2
<p>This parameter sets the current limiting point when the drive is in motoring mode in the reverse direction. The limit is expressed as a percentage of the current capacity of the drive.</p>		
<b>603 Cur Lim Reg Fwd</b>	Default: 80%	Range: 5-150% Level 2
<p>This parameter sets the current limiting point when the drive is in regenerative mode in the forward direction. The limit is expressed as a percentage of the current capacity of the drive.</p>		
<b>604 Cur Lim Reg Rev</b>	Default: 80%	Range: 5-150% Level 2
<p>This parameter sets the current limiting point when the drive is in regenerative mode in the reverse direction. The limit is expressed as a percentage of the current capacity of the drive.</p>		
<b>605 Cur Lim Freq</b>	Default: 3.0 Hz	Range: 0.0 - 400.0 Hz Level 2
<p>This parameter sets the frequency where current limit becomes active. This value will also be the frequency point the drive will decelerate the motor to during Motoring Current Limit.</p>		
<b>606 Ramp Time CL</b>	Default: 1.0 sec	Range: 0.1-3200.0 sec Level 2
<p>This parameter determines the ramp rate when the drive enters Current Limit, and defines the ramping rate of the drive when in a current limiting mode. If the drive is in regenerative current limit, it is an acceleration time. If the drive is in motoring current limit, it is a deceleration time.</p>		
<b>607 Cur Lim Minimum</b>	Default: 10%	Range: 0 - 50% Level 2
<p>This parameter limits the lowest amount of current (or Torque) limiting that can occur when the limit threshold is determined by an analog input.</p>		

**Table 7-2: Description of X4 Parameters** (Page 15 of 26)

<b>608 Restart Number</b>	Default: 0	P608 Range: 0-8
<b>609 Restart Delay</b>	Default: 60 sec	P609 Range: 0-60 sec Level 2

You may configure the drive to attempt to re-start a specified number of times after certain faults occur. Chapter 8 lists all faults and notes which ones may be reset automatically.

The number of attempts at re-starting is set with parameter **608 (Restart Number)**. A value of 0 prevents the drive from attempting a re-start. The time duration that must elapse between re-start attempts is set with parameter **609 (Restart Delay)**. The type of start to be attempted is set with parameter **802 (Start Options)**; see page 69).

If the number of attempted re-starts is exceeded, the drive will trip with a fault and will stop operating. **Resetting the fault can result in instant starting.** (See page 83 for more information on faults and troubleshooting.)

Note that for 2-wire operation, the FWD or REV terminal must still be active for the drive to attempt a re-start.

Also note that the counter for attempted re-starts will not reset to zero until ten minutes after a successful re-start.

<b>⚠ WARNING</b>
<b>UNINTENDED EQUIPMENT ACTION</b>
Ensure that automatic re-starting will not cause injury to personnel or damage to equipment.
<b>Failure to observe this instruction can result in serious injury or equipment damage.</b>

<b>⚠ AVERTISSEMENT</b>
<b>ACTIONNEMENT INVOLONTAIRE DE L'APPAREIL</b>
Assurez-vous qu'un redémarrage automatique n'entraînera ni des blessures au personnel ni des dommages matériels.
<b>Si cette directive n'est pas respectée, cela peut entraîner des blessures graves ou des dommages matériels.</b>

<b>610 Timed OL Select</b>	Default: Std Ind 60s	Range: 0-7 Level 2
----------------------------	----------------------	-----------------------

Two parameters in the X4 work together to configure how the motor timed overload operates: Parameter **510 (Rated Mtr FLA)** and Parameter **610 (Timed OL Select)**.

Parameter **510 (Rated Mtr FLA)** should be configured to the value on the nameplate of the motor. This value is used in calculating the percentage of current at which the drive is operating.

Set parameter **610** to one of the following data values to configure the desired overload characteristic:

<u>Options</u>	<u>Trip Time</u>	<u>Motor Type</u>	<u>Motor Class</u>
Std Ind Shp	0 sec	Standard Induction	N/A
Std Ind 30s	30 sec	Standard Induction	1
Std Ind 60s	60 sec	Standard Induction	2
Std Ind 5mn	300 sec	Standard Induction	10
In Duty Shp	0 sec	Inverter Duty	N/A
In Duty 30s	30 sec	Inverter Duty	1
In Duty 60s	60 sec	Inverter Duty	2
In Duty 5mn	300 sec	Inverter Duty	10

Parameter **610 (Timed OL Select)** determines the graph of Trip (Fault) Time vs. Percent Current that is used by the Motor TOL functionality. This protective feature is speed-dependent to handle standard induction motors whose cooling is limited by the shaft-mounted fan. Blower-cooled motors and most inverter-duty motors do not have this limitation.

<b>613 Max Regen Ramp</b>	Default: 300%	Range: 100 - 1000% Level 2
---------------------------	---------------	-------------------------------

This parameter operates as a percentage of the longest ramp time. This time then defines the amount of time a deceleration to stop can take without causing a "Regen Timeout" fault. For example, if "Decel Time 1" is 5.0 seconds, "Decel Time 2" is 10.0 seconds, and "Max Regen Ramp" is 300%, a deceleration to stop that takes more than 30 seconds will cause a "Regen Timeout" fault in the drive.



**Table 7-2: Description of X4 Parameters** (Page 16 of 26)

<b>700 Vmet Config</b>	Default: Freq Out	Range: n/a Levels 1,2																											
<p>This parameter configures the analog signal that will be applied to the Vmet output pin. The following data values may be assigned to this parameter:</p> <table border="1"> <thead> <tr> <th><u>Para. Value</u></th> <th><u>Description</u></th> <th><u>Range Limit</u></th> </tr> </thead> <tbody> <tr> <td>Freq Out</td> <td>Output frequency of the drive</td> <td>Parameter max freq.</td> </tr> <tr> <td>Voltage Out</td> <td>Voltage being supplied to the motor</td> <td>Rated motor voltage</td> </tr> <tr> <td>Current Out</td> <td>Current being supplied to the motor</td> <td>200% of drive rating</td> </tr> <tr> <td>Drive Load</td> <td>Calculated percentage of drive rating</td> <td>200% of drive rating</td> </tr> <tr> <td>Drive Temp</td> <td>Calculation of total drive temp rating</td> <td>100% of unit temp rating</td> </tr> <tr> <td>Stator Freq</td> <td>Commanded frequency</td> <td>100% of input config</td> </tr> <tr> <td>Power Out</td> <td>Calculated power output of drive</td> <td>250% of drive rating</td> </tr> <tr> <td>PI Fback</td> <td colspan="2">Allows the analog output to produce a signal in proportion to the PI feedback received.</td> </tr> </tbody> </table>			<u>Para. Value</u>	<u>Description</u>	<u>Range Limit</u>	Freq Out	Output frequency of the drive	Parameter max freq.	Voltage Out	Voltage being supplied to the motor	Rated motor voltage	Current Out	Current being supplied to the motor	200% of drive rating	Drive Load	Calculated percentage of drive rating	200% of drive rating	Drive Temp	Calculation of total drive temp rating	100% of unit temp rating	Stator Freq	Commanded frequency	100% of input config	Power Out	Calculated power output of drive	250% of drive rating	PI Fback	Allows the analog output to produce a signal in proportion to the PI feedback received.	
<u>Para. Value</u>	<u>Description</u>	<u>Range Limit</u>																											
Freq Out	Output frequency of the drive	Parameter max freq.																											
Voltage Out	Voltage being supplied to the motor	Rated motor voltage																											
Current Out	Current being supplied to the motor	200% of drive rating																											
Drive Load	Calculated percentage of drive rating	200% of drive rating																											
Drive Temp	Calculation of total drive temp rating	100% of unit temp rating																											
Stator Freq	Commanded frequency	100% of input config																											
Power Out	Calculated power output of drive	250% of drive rating																											
PI Fback	Allows the analog output to produce a signal in proportion to the PI feedback received.																												
<b>701 Vmet Span</b>	Default: 100%	Range: 0.0%-200.0% Level 2																											
<p>This parameter sets the span of the Vmet analog output.</p>																													
<b>702 Imet Config</b>	Default: Drive Load	Range: n/a Level 2																											
<p>This parameter configures the analog signal that will be applied to the Imet output pin. The following data values may be assigned to this parameter:</p> <table border="1"> <thead> <tr> <th><u>Para. Value</u></th> <th><u>Description</u></th> <th><u>Range Limit</u></th> </tr> </thead> <tbody> <tr> <td>Freq Out</td> <td>Output frequency of the drive</td> <td>Parameter max freq.</td> </tr> <tr> <td>Voltage Out</td> <td>Voltage being supplied to the motor</td> <td>Rated motor voltage</td> </tr> <tr> <td>Current Out</td> <td>Current being supplied to the motor</td> <td>200% of drive rating</td> </tr> <tr> <td>Drive Load</td> <td>Calculated percentage of drive rating</td> <td>200% of drive rating</td> </tr> <tr> <td>Drive Temp</td> <td>Calculation of total drive temp rating</td> <td>100% of unit temp rating</td> </tr> <tr> <td>Stator Freq</td> <td>Commanded frequency</td> <td>100% of input config</td> </tr> <tr> <td>Power Out</td> <td>Calculated power output of drive</td> <td>250% of drive rating</td> </tr> <tr> <td>PI Fback</td> <td colspan="2">Allows the analog output to produce a signal in proportion to the PI feedback received.</td> </tr> </tbody> </table>			<u>Para. Value</u>	<u>Description</u>	<u>Range Limit</u>	Freq Out	Output frequency of the drive	Parameter max freq.	Voltage Out	Voltage being supplied to the motor	Rated motor voltage	Current Out	Current being supplied to the motor	200% of drive rating	Drive Load	Calculated percentage of drive rating	200% of drive rating	Drive Temp	Calculation of total drive temp rating	100% of unit temp rating	Stator Freq	Commanded frequency	100% of input config	Power Out	Calculated power output of drive	250% of drive rating	PI Fback	Allows the analog output to produce a signal in proportion to the PI feedback received.	
<u>Para. Value</u>	<u>Description</u>	<u>Range Limit</u>																											
Freq Out	Output frequency of the drive	Parameter max freq.																											
Voltage Out	Voltage being supplied to the motor	Rated motor voltage																											
Current Out	Current being supplied to the motor	200% of drive rating																											
Drive Load	Calculated percentage of drive rating	200% of drive rating																											
Drive Temp	Calculation of total drive temp rating	100% of unit temp rating																											
Stator Freq	Commanded frequency	100% of input config																											
Power Out	Calculated power output of drive	250% of drive rating																											
PI Fback	Allows the analog output to produce a signal in proportion to the PI feedback received.																												
<b>703 Imet Span</b>	Default: 100%	Range: 0.0%-200.0% Level 2																											
<p>This parameter sets the span of the Imet analog output.</p>																													
<b>704 Imet Offset</b>	Default: 0.0%	Range: 0.0%-90.0% Level 2																											
<p>This parameter sets the offset of the Imet analog output.</p>																													

**Table 7-2: Description of X4 Parameters** (Page 17 of 26)

<b>705 Relay 1 Select</b> <b>706 Relay 2 Select</b> <b>707 DO1 Select</b> <b>708 DO2 Select</b>	Default: Drv Fault Default: Drv Run Default: Drv Ready Default: At Speed	Range for Parameters 705-708: n/a Levels 1, 2 for Parameters 705-706 Level 2 for Parameters 707-708																																	
These four parameters configure what condition will cause relays R1, R2, ST1, and ST2 to activate. Parameter 705 is associated with relay R1; parameter 706 with relay R2; parameter 707 with ST1; and parameter 708 with relay ST2. The following values may be assigned:																																			
<table border="1"> <thead> <tr> <th><u>Parameter Value</u></th> <th><u>Description</u></th> </tr> </thead> <tbody> <tr> <td>Drv Ready</td> <td>The drive is ready. (The relay will be open in Fault and Low Voltage conditions.)</td> </tr> <tr> <td>Drv Fault</td> <td>A fault occurs. (If automatic fault reset and re-start is enabled, only faults that cannot be reset will activate the relay. The relay will also activate for faults that can be reset when the number of re-start attempts exceeds the value set in parameter <b>608 (Restart Number)</b>.)</td> </tr> <tr> <td>Drive Run</td> <td>The drive has received a direction command.</td> </tr> <tr> <td>Running FWD</td> <td>The motor is running Forward and the output frequency is above 0.5 Hz.</td> </tr> <tr> <td>Running REV</td> <td>The motor is running in Reverse and the output frequency is above 0.5 Hz.</td> </tr> <tr> <td>Zero Speed</td> <td>The drive is in Run mode, but the speed reference is 0 Hz.</td> </tr> <tr> <td>At Speed</td> <td>The drive has reached reference speed.</td> </tr> <tr> <td>Freq Limit</td> <td>The drive limit is active when the speed commanded exceeds the value of parameter <b>306, Preset Freq 4</b>.</td> </tr> <tr> <td>Freq Hyst</td> <td>This is active when the speed exceeds parameter <b>306 (Preset Freq 4)</b> but is less than parameter <b>307 (Preset Freq 5)</b>.</td> </tr> <tr> <td>Current Lim</td> <td>Current Limit mode is active.</td> </tr> <tr> <td>High Temp</td> <td>The temperature limit of the drive has been exceeded.</td> </tr> <tr> <td>Local Mode</td> <td>The keypad is the control path for reference speed and control functions.</td> </tr> <tr> <td>SeqOut-00</td> <td rowspan="4">                     Programmed sequence step active. SeqOut-00, SeqOut-01, SeqOut-10, SeqOut-11 are all status outputs linked to a step in the program sequencer.                       See "Using the X4 Program Sequencer" on page 75 for more information.                 </td> </tr> <tr> <td>SeqOut-01</td> </tr> <tr> <td>SeqOut-10</td> </tr> <tr> <td>SeqOut-11</td> </tr> <tr> <td>ARCTIC</td> <td>When a digital output is configured to use this option, the output will be active when the Arctic Mode is turning on the DB resistor. This option will turn on when the temperature drops below the Arctic mode entry point, which is -7 degrees C. This will work even if Arctic Mode is not enabled.</td> </tr> </tbody> </table>			<u>Parameter Value</u>	<u>Description</u>	Drv Ready	The drive is ready. (The relay will be open in Fault and Low Voltage conditions.)	Drv Fault	A fault occurs. (If automatic fault reset and re-start is enabled, only faults that cannot be reset will activate the relay. The relay will also activate for faults that can be reset when the number of re-start attempts exceeds the value set in parameter <b>608 (Restart Number)</b> .)	Drive Run	The drive has received a direction command.	Running FWD	The motor is running Forward and the output frequency is above 0.5 Hz.	Running REV	The motor is running in Reverse and the output frequency is above 0.5 Hz.	Zero Speed	The drive is in Run mode, but the speed reference is 0 Hz.	At Speed	The drive has reached reference speed.	Freq Limit	The drive limit is active when the speed commanded exceeds the value of parameter <b>306, Preset Freq 4</b> .	Freq Hyst	This is active when the speed exceeds parameter <b>306 (Preset Freq 4)</b> but is less than parameter <b>307 (Preset Freq 5)</b> .	Current Lim	Current Limit mode is active.	High Temp	The temperature limit of the drive has been exceeded.	Local Mode	The keypad is the control path for reference speed and control functions.	SeqOut-00	Programmed sequence step active. SeqOut-00, SeqOut-01, SeqOut-10, SeqOut-11 are all status outputs linked to a step in the program sequencer.  See "Using the X4 Program Sequencer" on page 75 for more information.	SeqOut-01	SeqOut-10	SeqOut-11	ARCTIC	When a digital output is configured to use this option, the output will be active when the Arctic Mode is turning on the DB resistor. This option will turn on when the temperature drops below the Arctic mode entry point, which is -7 degrees C. This will work even if Arctic Mode is not enabled.
<u>Parameter Value</u>	<u>Description</u>																																		
Drv Ready	The drive is ready. (The relay will be open in Fault and Low Voltage conditions.)																																		
Drv Fault	A fault occurs. (If automatic fault reset and re-start is enabled, only faults that cannot be reset will activate the relay. The relay will also activate for faults that can be reset when the number of re-start attempts exceeds the value set in parameter <b>608 (Restart Number)</b> .)																																		
Drive Run	The drive has received a direction command.																																		
Running FWD	The motor is running Forward and the output frequency is above 0.5 Hz.																																		
Running REV	The motor is running in Reverse and the output frequency is above 0.5 Hz.																																		
Zero Speed	The drive is in Run mode, but the speed reference is 0 Hz.																																		
At Speed	The drive has reached reference speed.																																		
Freq Limit	The drive limit is active when the speed commanded exceeds the value of parameter <b>306, Preset Freq 4</b> .																																		
Freq Hyst	This is active when the speed exceeds parameter <b>306 (Preset Freq 4)</b> but is less than parameter <b>307 (Preset Freq 5)</b> .																																		
Current Lim	Current Limit mode is active.																																		
High Temp	The temperature limit of the drive has been exceeded.																																		
Local Mode	The keypad is the control path for reference speed and control functions.																																		
SeqOut-00	Programmed sequence step active. SeqOut-00, SeqOut-01, SeqOut-10, SeqOut-11 are all status outputs linked to a step in the program sequencer.  See "Using the X4 Program Sequencer" on page 75 for more information.																																		
SeqOut-01																																			
SeqOut-10																																			
SeqOut-11																																			
ARCTIC	When a digital output is configured to use this option, the output will be active when the Arctic Mode is turning on the DB resistor. This option will turn on when the temperature drops below the Arctic mode entry point, which is -7 degrees C. This will work even if Arctic Mode is not enabled.																																		
<b>720 Active Logic</b>	Default: Active High	Range: n/a Level 2																																	
This parameter configures the input state of all the digital inputs except the EN digital input. The EN digital input is always active high. The following data values may be assigned to this parameter:																																			
<table border="1"> <thead> <tr> <th><u>Parameter Value</u></th> <th><u>Description</u></th> </tr> </thead> <tbody> <tr> <td>Active Low</td> <td>Low input is true ("pull-down logic")</td> </tr> <tr> <td>Active High</td> <td>High input is true ("pull-up logic")</td> </tr> </tbody> </table>			<u>Parameter Value</u>	<u>Description</u>	Active Low	Low input is true ("pull-down logic")	Active High	High input is true ("pull-up logic")																											
<u>Parameter Value</u>	<u>Description</u>																																		
Active Low	Low input is true ("pull-down logic")																																		
Active High	High input is true ("pull-up logic")																																		

**Table 7-2: Description of X4 Parameters** (Page 18 of 26)

<b>721 DI1 Configure</b>	Default: Preset 1	Range: n/a Level 2
<b>722 DI2 Configure</b>	Default: Preset 2	
<b>723 DI3 Configure</b>	Default: Preset 3	
<b>724 DI4 Configure</b>	Default: Alt Ramp	
<b>725 DI5 Configure</b>	Default: Fault Reset	

These parameters configure the function that the digital inputs DI1-5 will perform when active. The following data values may be assigned:

<u>Parameter Value</u>	<u>Description</u>
Preset 1	Preset Speed Input 1 (PS1).
Preset 2	Preset Speed Input 2 (PS2).
Preset 3	Preset Speed Input 3 (PS3).
Coast Stop	Activates a Coast-to-Stop condition.
DC Inject	Begins DC injection braking.
Loc/Rem	Switches from Local to Remote mode.
Alt Ramp	Activates Alternate Ramp.
Fault Reset	Resets a fault.
EMOP+	EMOP increases speed.
EMOP-	EMOP decreases speed.
PI Enable	Enables PI control.
Ref Switch	Switches speed reference signals.
Cur Lim Dis	Disables Current Limit mode.
CurLimMax	Sets all Current Limit inputs at the maximum value the drive will allow.
SL Override	Takes control away from the serial link.
Seq 1	Sequencer input 1.
Seq 2	Sequencer input 2.
Seq 3	Sequencer input 3.
Seq Dwell	Sequencer dwell mode (pause).
Seq Advance	Sequencer advance (skip).
FLY Dis	Disable Catch-on-fly operation.

<b>726 MOL Polarity</b>	Default: NO Operate	Range: n/a Level 2
-------------------------	---------------------	-----------------------

This parameter sets the Motor Overload input polarity. The following data values may be assigned to this parameter:

<u>Parameter Value</u>	<u>Description</u>
NC Operate	A normally closed (NC) connection allows the unit to operate; the drive faults when the connection opens.
NO Operate	A normally open (NO) connection allows the unit to operate; the drive faults when the connection closes.

**Table 7-2: Description of X4 Parameters** (Page 19 of 26)

727 MOL Configure	Default: MOL	Range: n/a Level 2																																														
<p>This parameter serves as the selection for the operation of the MOL terminal. The polarity of the MOL digital input is still determined by Parameter 726, MOL Polarity. The options for this parameter and all of the additional digital input parameters are as follows:</p>																																																
<table border="0"> <thead> <tr> <th data-bbox="315 453 477 478"><u>Parameter Value</u></th> <th data-bbox="505 453 610 478"><u>Description</u></th> </tr> </thead> <tbody> <tr><td>Preset 1</td><td>Preset Speed Input 1 (PS1).</td></tr> <tr><td>Preset 2</td><td>Preset Speed Input 2 (PS2).</td></tr> <tr><td>Preset 3</td><td>Preset Speed Input 3 (PS3).</td></tr> <tr><td>Coast Stop</td><td>Activates a Coast-to-Stop condition.</td></tr> <tr><td>DC Inject</td><td>Begins DC injection braking.</td></tr> <tr><td>Loc/Rem</td><td>Switches from Local to Remote mode.</td></tr> <tr><td>Alt Ramp</td><td>Activates Alternate Ramp.</td></tr> <tr><td>Fault Reset</td><td>Resets a fault.</td></tr> <tr><td>EMOP+</td><td>EMOP increases speed.</td></tr> <tr><td>EMOP-</td><td>EMOP decreases speed.</td></tr> <tr><td>PID Enable</td><td>Enables PI control.</td></tr> <tr><td>Ref Switch</td><td>Switches speed reference signals.</td></tr> <tr><td>Cur Lim Dis</td><td>Disables Current Limit mode.</td></tr> <tr><td>SL Override</td><td>Takes control away from the serial link.</td></tr> <tr><td>Seq 1</td><td>Sequencer input 1.</td></tr> <tr><td>Seq 2</td><td>Sequencer input 2.</td></tr> <tr><td>Seq 3</td><td>Sequencer input 3.</td></tr> <tr><td>Seq Dwell</td><td>Sequencer dwell mode (pause).</td></tr> <tr><td>Seq Advance</td><td>Sequencer advance (skip).</td></tr> <tr><td>FLY Dis</td><td>Disable Catch-on-fly operation.</td></tr> <tr><td>CurLimMax</td><td>Maximum current limit value is selected when input is active.</td></tr> <tr><td>MOL</td><td>Motor Overload input for external customer connection.</td></tr> </tbody> </table>			<u>Parameter Value</u>	<u>Description</u>	Preset 1	Preset Speed Input 1 (PS1).	Preset 2	Preset Speed Input 2 (PS2).	Preset 3	Preset Speed Input 3 (PS3).	Coast Stop	Activates a Coast-to-Stop condition.	DC Inject	Begins DC injection braking.	Loc/Rem	Switches from Local to Remote mode.	Alt Ramp	Activates Alternate Ramp.	Fault Reset	Resets a fault.	EMOP+	EMOP increases speed.	EMOP-	EMOP decreases speed.	PID Enable	Enables PI control.	Ref Switch	Switches speed reference signals.	Cur Lim Dis	Disables Current Limit mode.	SL Override	Takes control away from the serial link.	Seq 1	Sequencer input 1.	Seq 2	Sequencer input 2.	Seq 3	Sequencer input 3.	Seq Dwell	Sequencer dwell mode (pause).	Seq Advance	Sequencer advance (skip).	FLY Dis	Disable Catch-on-fly operation.	CurLimMax	Maximum current limit value is selected when input is active.	MOL	Motor Overload input for external customer connection.
<u>Parameter Value</u>	<u>Description</u>																																															
Preset 1	Preset Speed Input 1 (PS1).																																															
Preset 2	Preset Speed Input 2 (PS2).																																															
Preset 3	Preset Speed Input 3 (PS3).																																															
Coast Stop	Activates a Coast-to-Stop condition.																																															
DC Inject	Begins DC injection braking.																																															
Loc/Rem	Switches from Local to Remote mode.																																															
Alt Ramp	Activates Alternate Ramp.																																															
Fault Reset	Resets a fault.																																															
EMOP+	EMOP increases speed.																																															
EMOP-	EMOP decreases speed.																																															
PID Enable	Enables PI control.																																															
Ref Switch	Switches speed reference signals.																																															
Cur Lim Dis	Disables Current Limit mode.																																															
SL Override	Takes control away from the serial link.																																															
Seq 1	Sequencer input 1.																																															
Seq 2	Sequencer input 2.																																															
Seq 3	Sequencer input 3.																																															
Seq Dwell	Sequencer dwell mode (pause).																																															
Seq Advance	Sequencer advance (skip).																																															
FLY Dis	Disable Catch-on-fly operation.																																															
CurLimMax	Maximum current limit value is selected when input is active.																																															
MOL	Motor Overload input for external customer connection.																																															
801 Program Number	Default: 0	Range: 0 to 9999 Level 2, Macro																																														
<p>This parameter (Special Program Number) provides a way of enabling hidden functions in the drive and storing parameters to the customer set.</p>																																																
<table border="0"> <thead> <tr> <th data-bbox="350 1262 456 1287"><u>Data Value</u></th> <th data-bbox="505 1262 769 1287"><u>Special Function Configured</u></th> </tr> </thead> <tbody> <tr><td>0</td><td>Standard program</td></tr> <tr><td>1</td><td>Reset all parameters to factory default values (display = SETP).</td></tr> <tr><td>2</td><td>Store customer parameter values (display = STOC).</td></tr> <tr><td>3</td><td>Load customer parameter values (display = SETC).</td></tr> <tr><td>4</td><td>Swap active parameters with customer stored settings.</td></tr> <tr><td>10</td><td>Reset Total Run Time, parameter 108.</td></tr> </tbody> </table>			<u>Data Value</u>	<u>Special Function Configured</u>	0	Standard program	1	Reset all parameters to factory default values (display = SETP).	2	Store customer parameter values (display = STOC).	3	Load customer parameter values (display = SETC).	4	Swap active parameters with customer stored settings.	10	Reset Total Run Time, parameter 108.																																
<u>Data Value</u>	<u>Special Function Configured</u>																																															
0	Standard program																																															
1	Reset all parameters to factory default values (display = SETP).																																															
2	Store customer parameter values (display = STOC).																																															
3	Load customer parameter values (display = SETC).																																															
4	Swap active parameters with customer stored settings.																																															
10	Reset Total Run Time, parameter 108.																																															

**Table 7-2: Description of X4 Parameters** (Page 20 of 26)

<b>802 Start Options</b>	Default: LS Lockout	Range: n/a Level 2																																								
<p>The Start Options parameter configures the Line Start Lockout functionality of the drive. All data values ending with "2" allow you to press the Enter key to store the customer speed reference value on the keypad. You must press and hold the Enter key for two seconds to save the speed command. The following data values may be assigned:</p> <table border="1"> <thead> <tr> <th>Data Value</th> <th>Description</th> </tr> </thead> <tbody> <tr> <td><b>LS Lockout</b></td> <td>(Line Start Lockout). If maintained contact run operators are used, they must be opened and then re-closed for the drive to start after AC power is applied.</td> </tr> <tr> <td><b>AutoStart</b></td> <td>When AC power is applied, if a Run command is present through the terminal strip, the drive will start.</td> </tr> <tr> <td><b>LSL w/FLY</b></td> <td>This setting has both LS Lockout and Catch on the Fly enabled at the same time.</td> </tr> <tr> <td><b>Auto w/FLY</b></td> <td>This setting has both Auto-Start and Catch on the Fly enabled at the same time.</td> </tr> <tr> <td><b>LS Lockout2</b></td> <td>(Line Start Lockout). If maintained contact run operators are used, they must be opened and then re-closed for the drive to start after AC power is applied.</td> </tr> <tr> <td><b>AutoStart2</b></td> <td>When AC power is applied, if a Run command is present through the terminal strip, the drive will start.</td> </tr> <tr> <td><b>LSL w/FLY 2</b></td> <td>This setting has both LS Lockout and Catch on the Fly enabled at the same time.</td> </tr> <tr> <td><b>Auto w/FLY2</b></td> <td>This setting has both Auto-Start and Catch on the Fly enabled at the same time.</td> </tr> </tbody> </table>			Data Value	Description	<b>LS Lockout</b>	(Line Start Lockout). If maintained contact run operators are used, they must be opened and then re-closed for the drive to start after AC power is applied.	<b>AutoStart</b>	When AC power is applied, if a Run command is present through the terminal strip, the drive will start.	<b>LSL w/FLY</b>	This setting has both LS Lockout and Catch on the Fly enabled at the same time.	<b>Auto w/FLY</b>	This setting has both Auto-Start and Catch on the Fly enabled at the same time.	<b>LS Lockout2</b>	(Line Start Lockout). If maintained contact run operators are used, they must be opened and then re-closed for the drive to start after AC power is applied.	<b>AutoStart2</b>	When AC power is applied, if a Run command is present through the terminal strip, the drive will start.	<b>LSL w/FLY 2</b>	This setting has both LS Lockout and Catch on the Fly enabled at the same time.	<b>Auto w/FLY2</b>	This setting has both Auto-Start and Catch on the Fly enabled at the same time.																						
Data Value	Description																																									
<b>LS Lockout</b>	(Line Start Lockout). If maintained contact run operators are used, they must be opened and then re-closed for the drive to start after AC power is applied.																																									
<b>AutoStart</b>	When AC power is applied, if a Run command is present through the terminal strip, the drive will start.																																									
<b>LSL w/FLY</b>	This setting has both LS Lockout and Catch on the Fly enabled at the same time.																																									
<b>Auto w/FLY</b>	This setting has both Auto-Start and Catch on the Fly enabled at the same time.																																									
<b>LS Lockout2</b>	(Line Start Lockout). If maintained contact run operators are used, they must be opened and then re-closed for the drive to start after AC power is applied.																																									
<b>AutoStart2</b>	When AC power is applied, if a Run command is present through the terminal strip, the drive will start.																																									
<b>LSL w/FLY 2</b>	This setting has both LS Lockout and Catch on the Fly enabled at the same time.																																									
<b>Auto w/FLY2</b>	This setting has both Auto-Start and Catch on the Fly enabled at the same time.																																									
<b>803 PWM Frequency</b>	Default: 3.0 kHz	Range: 0.6-16.0 kHz Level 2																																								
<p>The PWM Carrier Frequency parameter sets the carrier frequency of the Pulse-Width Modulation (PWM) waveform supplied to the motor. Low carrier frequencies provide better low-end torque, but produce some audible noise from the motor. Higher carrier frequencies produce less audible noise, but cause more heating in the drive and motor.</p>																																										
<b>804 Display Mode</b>	Default: Std Disply	Range: n/a Level 2																																								
<p>The Display Mode parameter determines how the reference or output of the drive will be displayed to the user. If User Units is selected, parameter 805 allows you to customize the 3 unit values on the display. The following data values may be assigned to this parameter:</p> <table border="1"> <thead> <tr> <th>Parameter Value</th> <th>Description</th> </tr> </thead> <tbody> <tr> <td>Std Disply</td> <td>Standard commanded frequency</td> </tr> <tr> <td>Out Freq</td> <td>Output frequency actually sent to the motor</td> </tr> <tr> <td>Stator Freq</td> <td>Frequency of the stator</td> </tr> <tr> <td>User Units</td> <td>Custom units display based on values in parameters 805, 806, and 807</td> </tr> <tr> <td>RPM Units</td> <td>Custom speed display with RPM as units</td> </tr> <tr> <td>GPM Units</td> <td>Custom speed display with GPM as units</td> </tr> <tr> <td>FPM Units</td> <td>Custom speed display with FPM as units</td> </tr> <tr> <td>MPM Units</td> <td>Custom speed display with MPM as units</td> </tr> <tr> <td>PSI Units</td> <td>Custom speed display with PSI as units</td> </tr> <tr> <td>Degrees C</td> <td>Custom display with degrees C</td> </tr> <tr> <td>Degrees F</td> <td>Custom display with degrees F</td> </tr> <tr> <td>Time hrs</td> <td>Custom display time in hours of operation</td> </tr> <tr> <td>Time min</td> <td>Custom display time in minutes of operation</td> </tr> <tr> <td>Time sec</td> <td>Custom display time in seconds of operation</td> </tr> <tr> <td>Time sec</td> <td>Custom display time in seconds of operation</td> </tr> <tr> <td>Fbk RPM</td> <td>Display is scaled to read in RPM based on the PI feedback input to an analog input</td> </tr> <tr> <td>Fbk PSI</td> <td>Display is scaled to read in PSI based on the PI feedback input to an analog input</td> </tr> <tr> <td>Fbk GPM</td> <td>Display is scaled to read in GPM based on the PI feedback input to an analog input</td> </tr> <tr> <td>Fbk User</td> <td>Display is scaled to read in User units (parameter 805) based on PI feedback input to an analog input</td> </tr> </tbody> </table> <p><i>When using any of the Time functions, these refer to "Retention Time." Retention time is an inverse function: as speed goes up, time goes down, and vice versa. It is typically used in oven-type applications. The value set in parameter 809 (Display Scale) references the time of operation when running at Max. Frequency. For instance, if parameter 302 (Max. Frequency) is set for 60 Hz, 804 (Display Mode) is set for Time min, and 809 (Display Scale) is set for 600, the scales of the display will read 60.0 min at maximum speed and increase in time (in minutes) up to the maximum scale of 6553.5 at minimum frequency.</i></p>			Parameter Value	Description	Std Disply	Standard commanded frequency	Out Freq	Output frequency actually sent to the motor	Stator Freq	Frequency of the stator	User Units	Custom units display based on values in parameters 805, 806, and 807	RPM Units	Custom speed display with RPM as units	GPM Units	Custom speed display with GPM as units	FPM Units	Custom speed display with FPM as units	MPM Units	Custom speed display with MPM as units	PSI Units	Custom speed display with PSI as units	Degrees C	Custom display with degrees C	Degrees F	Custom display with degrees F	Time hrs	Custom display time in hours of operation	Time min	Custom display time in minutes of operation	Time sec	Custom display time in seconds of operation	Time sec	Custom display time in seconds of operation	Fbk RPM	Display is scaled to read in RPM based on the PI feedback input to an analog input	Fbk PSI	Display is scaled to read in PSI based on the PI feedback input to an analog input	Fbk GPM	Display is scaled to read in GPM based on the PI feedback input to an analog input	Fbk User	Display is scaled to read in User units (parameter 805) based on PI feedback input to an analog input
Parameter Value	Description																																									
Std Disply	Standard commanded frequency																																									
Out Freq	Output frequency actually sent to the motor																																									
Stator Freq	Frequency of the stator																																									
User Units	Custom units display based on values in parameters 805, 806, and 807																																									
RPM Units	Custom speed display with RPM as units																																									
GPM Units	Custom speed display with GPM as units																																									
FPM Units	Custom speed display with FPM as units																																									
MPM Units	Custom speed display with MPM as units																																									
PSI Units	Custom speed display with PSI as units																																									
Degrees C	Custom display with degrees C																																									
Degrees F	Custom display with degrees F																																									
Time hrs	Custom display time in hours of operation																																									
Time min	Custom display time in minutes of operation																																									
Time sec	Custom display time in seconds of operation																																									
Time sec	Custom display time in seconds of operation																																									
Fbk RPM	Display is scaled to read in RPM based on the PI feedback input to an analog input																																									
Fbk PSI	Display is scaled to read in PSI based on the PI feedback input to an analog input																																									
Fbk GPM	Display is scaled to read in GPM based on the PI feedback input to an analog input																																									
Fbk User	Display is scaled to read in User units (parameter 805) based on PI feedback input to an analog input																																									

**Table 7-2: Description of X4 Parameters** (Page 21 of 26)

<b>805 Display Units(1)</b>	Default: RPM: 1	Range: n/a Level 2
This parameter determines the three-character customer display units used when parameter <b>804</b> is set to User Units. The last digit indicates the number of decimal places to be shown on the display. Up to three decimal places are possible.		
<b>809 Display Scale</b>	Default: 1	Range: 1-65535 Level 2
This parameter determines how the reference or output of the drive will be displayed to the user. It selects the maximum scaling of the display when running at maximum frequency.		
<b>810 Language</b>	Default: English	Range: 1-65535 Level 2, Macro
This parameter configures the language text strings will be displayed in. The following data values may be assigned: <u>Parameter Value</u> English            Italian Spanish            French German		
<b>811 Access Code</b>	Default: 0	Range: 0-9999 Level 2
The security <b>Access Code</b> allows the user to control access to the programmable functions of the inverter. The initial value of this parameter is 000, which signifies that no access code is necessary. Any number between 001 and 999 may be used for an access code, but is not necessary. If an access code is entered, you will not be able to view the values while scrolling through parameters. Only after the Shift key is pressed will the actual value appear.  To enter an access code, re-program parameter <b>811</b> as you would any other parameter. After the new value is stored, you have 10 minutes of free access. If you remove power and then restore it, you will need to enter the access code to change any program parameter. If you enter an incorrect access code, the drive displays <b>**WRONG CODE**</b> and allows only viewing rights to the various parameters. Once the correct code is entered, you again have 10 minutes of free access unless power is removed and restored. To disable the access code requirement, set parameter <b>811</b> back to 000.		
<b>812 Freq Ref Output</b>	Default: 6FS	Range: n/a Level 2
The <b>Frequency Reference Output</b> parameter determines the frequency pulse-train output from the DOP terminal. This digital output is a pulse train that can be linked to another drive or to a field meter for speed indication. The pulse train is a 50% duty cycle signal and requires a pull-up resistor of approximately 4.7 kOhms.  The following data values may be assigned to this parameter: <u>Parameter Value</u> 6FS 48FS		
<b>813 Speed Ratio</b>	Default: 100.0%	Range: 0.0%-200.0% Level 2
The <b>Master / Follower Speed Ratio</b> parameter allows the pulse train output of one X4 series drive (master) to be used to control the speed of up to 8 other follower drives. The output of each follower can be individually programmed, or trimmed "ON-THE-FLY" with A2-RATIO. The range of adjustment is 0-200% of the master. This function only works when using the 6FS function in parameter <b>204</b> .		

**Table 7-2: Description of X4 Parameters** (Page 22 of 26)

<b>814 Display Status</b>	Default: Drive Load	Range: 0.0%-200.0% Level 2
This parameter allows configuration of the additional parameter status field on the operate screen. The following fields can be configured:		
<u>Parameter Value</u>	<u>Description</u>	<u>Range Limit</u>
Voltage Out	Voltage being supplied to the motor	Rated motor voltage
Current Out	Current being supplied to the motor	200% of drive rating
Drive Load	Calculated percentage of drive rating	200% of drive rating
Drive Temp	Calculation of total drive temp rating	100% of unit temp rating
Power Out	Calculated power output of drive	250% of drive rating
% of FLA	Calculated percentage of drive rating	Percent of motor FLA
<b>816 Fly Catch Mode</b>	Default: Sweep Fwd	Range: n/a Level 2
This parameter configures how the "catch on the fly" operates.		
<u>Parameter Value</u>	<u>Description</u>	
Sweep Fwd	Catch on the fly algorithm sweeps through frequencies only in the forward direction while searching for the operating frequency	
Sweep Rev	Catch on the fly algorithm sweeps through frequencies only in the reverse direction while searching for the operating frequency	
Sweep F/R	Catch on the fly algorithm sweeps through frequencies in both directions while searching for the operating frequency. The direction that is chosen first depends on the direction of the command given to the drive. Note that this option is slower than the other two modes of operation.	
<b>850 PI Configure</b>	Default: No PI	Range: n/a Level 2
The PI Configure parameter determines what type of PI control is active in the drive.		
PI can be active at all times, or activated using a digital input. If you select a digital input or function key as the means to enable PI control, remember to configure the parameter that sets the function of the digital input or function key to enable PI control to complete the implementation.		
The following data values may be assigned to this parameter:		
<u>Parameter Value</u>	<u>Description</u>	
No PI	PI control is always inactive.	
Dir F-FWD	Direct action with feed-forward.	
Rev F-FWD	Reverse action with feed-forward.	
Dir F-FWD E	Direct action with feed-forward, with PI enabled by DI.	
Rev F-FWD E	Reverse action with feed-forward, with PI enabled by DI.	
Dir Full	Direct action with full range.	
Rev Full	Reverse action with full range.	
Dir Full E	Direct action with full range, with PI enabled by DI.	
Rev Full E	Reverse action with full range, with PI enabled by DI.	
<b>851 PI Feedback</b>	Default: Vin1	Range: n/a Level 2
The PI Feedback parameter configures the feedback signal to be used in PI control.		
The following data values may be assigned to this parameter:		
<u>Parameter Value</u>	<u>Description</u>	
Vin1	Vin1 is the PI feedback.	
Cin	Cin is the PI feedback.	
Vin2	Vin2 is the PI feedback.	

**Table 7-2: Description of X4 Parameters** (Page 23 of 26)

<b>852 PI Prop Gain</b>	Default: 0	Range: 0-2000 Level 2										
The PI Proportional Gain parameter configures the proportional gain that is applied to the PI control. <b>Note:</b> Value must be greater than 0 for this to be active.												
<b>853 PI Int Gain</b>	Default: 0	Range: 0-10000 Level 2										
The PI Integral Gain parameter configures the integral gain that is applied to the PI control. <b>Note:</b> Value must be greater than 0 for this to be active.												
<b>854 PI Feed Gain</b>	Default: 1000	Range: 0-2000 Level 2										
The PI Feed Gain parameter allows the feedback signal to be scaled. A setting of 1000 indicates 100.0%.												
<b>855 PI Error 1</b> <b>856 PI Error 2</b>	Default: Read-Only	Range: 0.00-100.00% Level 2										
Both the PI Error 1 and PI Error 2 parameters are read-only; they provide feedback on how the PI control is operating.												
<b>857 PI High Corr</b>	Default: 100.00%	Range: 0.00-100.00% Level 2										
This parameter sets the high limit of the PI output.												
<b>858 PI Low Corr</b>	Default: 0.00%	Range: 0.00-100.00% Level 2										
This parameter sets the low limit of the PI output.												
<b>900 SIO Protocol</b>	Default: RTU N81	Range: n/a Level 2 (SIO)										
This parameter defines the protocol and the parity of the SIO port. The following data values may be assigned to this parameter:												
<table border="1"> <thead> <tr> <th><u>Parameter Value</u></th> <th><u>Description</u></th> </tr> </thead> <tbody> <tr> <td>RTU N81</td> <td>No parity, 8 data bits, 1 stop bit</td> </tr> <tr> <td>RTU N82</td> <td>No parity, 8 data bits, 2 stop bits</td> </tr> <tr> <td>RTU E81</td> <td>Even parity, 8 data bits, 1 stop bit</td> </tr> <tr> <td>RTU O81</td> <td>Odd parity, 8 data bits, 1 stop bit</td> </tr> </tbody> </table>			<u>Parameter Value</u>	<u>Description</u>	RTU N81	No parity, 8 data bits, 1 stop bit	RTU N82	No parity, 8 data bits, 2 stop bits	RTU E81	Even parity, 8 data bits, 1 stop bit	RTU O81	Odd parity, 8 data bits, 1 stop bit
<u>Parameter Value</u>	<u>Description</u>											
RTU N81	No parity, 8 data bits, 1 stop bit											
RTU N82	No parity, 8 data bits, 2 stop bits											
RTU E81	Even parity, 8 data bits, 1 stop bit											
RTU O81	Odd parity, 8 data bits, 1 stop bit											
<b>901 SIO Baud Rate</b>	Default: 9600	Range: n/a Level 2 (SIO)										
This parameter defines the baud rate of the SIO port. The following data values may be assigned to this parameter:												
<table border="1"> <thead> <tr> <th><u>Parameter Value</u></th> </tr> </thead> <tbody> <tr> <td>4800</td> </tr> <tr> <td>9600</td> </tr> <tr> <td>19200</td> </tr> <tr> <td>38400</td> </tr> <tr> <td>57600</td> </tr> </tbody> </table>			<u>Parameter Value</u>	4800	9600	19200	38400	57600				
<u>Parameter Value</u>												
4800												
9600												
19200												
38400												
57600												
<b>902 Comm Drop #</b>	Default: 1	Range: 1-247 Level 2 (SIO)										
This parameter defines the network drop number for both SIO and IRDA communications.												
<b>903 SIO Timer</b>	Default: 1.0 sec	Range: 0.0-60.0 sec Level 2 (SIO)										
This parameter defines a watchdog timer that will require a valid communication in the specified time period while in SIO control. If the requirement is not met, a fault occurs.												



**Table 7-2: Description of X4 Parameters** (Page 24 of 26)

<b>904 SIO Cntl Word</b>	Default: 0x0000	Range: n/a Level 2 (SIO)
--------------------------	-----------------	-----------------------------

The SIO Control Word parameter allows control of the drive through Modbus communications.

The following bits are used with this parameter:

15	14	13	12	11	10	9	8	7	6	5	4	3	2	1	0	
<b>Bit</b>	<b>When Set to 1 Signifies</b>							<b>Bit</b>	<b>When Set to 1 Signifies</b>							
8	Alt Ramp							0	SLC (Run)							
9	PI Enable							1	SLF (Ref)							
10	Not Used							2	FWD							
11	Cur Lim							3	REV							
12	DCI							4	FEXT2							
13	CTS							5	Preset Input 1 (PS1)							
14	Ref Switch							6	Preset Input 2 (PS2)							
15	Fault Reset							7	Preset Input 3 (PS3)							

<b>905 Ext Ref Freq 1</b>	Default: 0.0 Hz	Range: Min. Freq.-Max. Freq. Level 2 (SIO)
<b>906 Ext Ref Freq 2</b>		

These parameters provide access for changing the frequency reference over the serial link.

<b>908 Status Word</b>	Default: Read-Only	Range: n/a Level 2 (SIO)
------------------------	--------------------	-----------------------------

The Status Word parameter provides status of the drive operation to a serial link user.

The following bits are used with this parameter:

15	14	13	12	11	10	9	8	7	6	5	4	3	2	1	0	
<b>Bit</b>	<b>When Set to 1 Signifies</b>							<b>Bit</b>	<b>When Set to 1 Signifies</b>							
8	Alt Ramp							0	SLC (Run)							
9	SL Override							1	SLF (Ref)							
10	Remote							2	FWD run							
11	Curr Lim							3	REV run							
12	DCI							4	FEXT2							
13	Jogging							5	Accel							
14	Zero Spd							6	Decel							
15	Drive Flt							7	At Speed							

<b>909 DI Status</b>	Default: Read-Only	Range: n/a Level 2 (SIO)
----------------------	--------------------	-----------------------------

This parameter provides a 10-bit status display.

The following bits are used with this parameter:

9	8	7	6	5	4	3	2	1	0		
<b>Bit</b>	<b>When Set to 1 Signifies</b>					<b>Bit</b>	<b>When Set to 1 Signifies</b>				
5	DI3 Input					0	FWD Input				
6	DI4 Input					1	REV Input				
7	DI5 Input					2	R/J Input				
8	MOL Input					3	DI1 Input				
9	EN Input					4	DI2 Input				

**Table 7-2: Description of X4 Parameters** (Page 25 of 26)

<b>910 Vin1 Status</b> <b>911 Cin Status</b> <b>912 Vin2 Status</b>	Default: Read-Only	Range: 0.00-100.00% Level 2 (SIO)																																																																						
Parameter <b>910</b> provides the input percentage applied to the Vin1 terminal; parameter <b>911</b> provides the input percentage applied to the Cin terminal; and parameter <b>912</b> provides the input percentage applied to the Vin2 terminal.																																																																								
<b>913 Output Status</b>	Default: Read-Only	Range: n/a Level 2 (SIO)																																																																						
This parameter provides a 10-bit binary status display. A "1" in the status word indicates that the output is active. The following bits are used with this parameter:																																																																								
<table border="1" style="width: 100%; border-collapse: collapse; text-align: center;"> <tr> <td style="width: 10%;">9</td><td style="width: 10%;">8</td><td style="width: 10%;">7</td><td style="width: 10%;">6</td><td style="width: 10%;">5</td><td style="width: 10%;">4</td><td style="width: 10%;">3</td><td style="width: 10%;">2</td><td style="width: 10%;">1</td><td style="width: 10%;">0</td> </tr> <tr> <td><b>Bit</b></td><td colspan="4"><b>When Set to 1 Signifies</b></td><td><b>Bit</b></td><td colspan="4"><b>When Set to 1 Signifies</b></td> </tr> <tr> <td>5</td><td colspan="4">N/A</td><td>0</td><td colspan="4">R1 Output</td> </tr> <tr> <td>6</td><td colspan="4">N/A</td><td>1</td><td colspan="4">R2 Output</td> </tr> <tr> <td>7</td><td colspan="4">N/A</td><td>2</td><td colspan="4">DO1 Output</td> </tr> <tr> <td>8</td><td colspan="4">N/A</td><td>3</td><td colspan="4">DO2 Output</td> </tr> <tr> <td>9</td><td colspan="4">N/A</td><td>4</td><td colspan="4">N/A</td> </tr> </table>			9	8	7	6	5	4	3	2	1	0	<b>Bit</b>	<b>When Set to 1 Signifies</b>				<b>Bit</b>	<b>When Set to 1 Signifies</b>				5	N/A				0	R1 Output				6	N/A				1	R2 Output				7	N/A				2	DO1 Output				8	N/A				3	DO2 Output				9	N/A				4	N/A			
9	8	7	6	5	4	3	2	1	0																																																															
<b>Bit</b>	<b>When Set to 1 Signifies</b>				<b>Bit</b>	<b>When Set to 1 Signifies</b>																																																																		
5	N/A				0	R1 Output																																																																		
6	N/A				1	R2 Output																																																																		
7	N/A				2	DO1 Output																																																																		
8	N/A				3	DO2 Output																																																																		
9	N/A				4	N/A																																																																		
<b>914 Vmet Status</b> <b>915 Imet Status</b>	Default: Read-Only	Range: 0.00-100.00% Level 2 (SIO)																																																																						
Parameter <b>914</b> provides the output percentage applied to the Vmet terminal; parameter <b>915</b> provides the output percentage applied to the Imet terminal.																																																																								
<b>916 Infrared Baud</b>	Default: 9600	Range: n/a Level 2 (SIO)																																																																						
This parameter defines the baud rate of the IRDA port. The following data values may be assigned to this parameter:																																																																								
<p><u>Parameter Value</u></p> 9600 19200 38400 57600																																																																								
<b>931 Seq Cntl 1</b> <b>932 Seq Cntl 2</b> <b>933 Seq Cntl 3</b> <b>934 Seq Cntl 4</b> <b>935 Seq Cntl 5</b> <b>936 Seq Cntl 6</b> <b>937 Seq Cntl 7</b> <b>938 Seq Cntl 8</b> <b>939 Seq Cntl 9</b>	Default: 00000000000	Range: n/a Level 2 (SEQ)																																																																						
These parameters each provide a 10-bit binary status display. See "Using the X4 Program Sequencer" on page 75. The following bits are used with each of these parameters:																																																																								
Bit 0-2=Speed Sel Bit 3=Accl Sel Bit 4-6=Event Length Bit 7-8=Dir Sel Bit 9-10=Output Sel																																																																								

**Table 7-2: Description of X4 Parameters** (Page 26 of 26)

951 Seq Count 1 952 Seq Count 2 953 Seq Count 3 954 Seq Count 4 955 Seq Count 5 956 Seq Count 6 957 Seq Count 7 958 Seq Count 8 959 Seq Count 9	Default: 0	Range: 0-65535 Level 2 (SEQ)
These parameters configure the time, number of pulses, or analog level of sequencer steps 1 through 9, respectively. See "Using the X4 Program Sequencer" on page 75.		

## 7.4 Using the X4 Program Sequencer

The X4 AC drive offers functionality that allows users to program up to nine independent operation states of the drive. This functionality is called the "program sequencer" because it allows the drive to sequence through the operation states programmed by the user. The X4 Program Sequencer can be used in applications that would normally require external intelligence, such as a simple programmable logic controller.

### 7.4.1 Enabling the X4 Program Sequencer

The X4 Program Sequencer can be enabled with parameter 491 (Seq Appl), found in the Application Macro programming mode of the X4 keypad. This parameter configures:

- Whether the sequencer is enabled,
- The time base used for all timing of the sequencer,
- Whether other sequencer parameters are visible in Level 2 programming.

Table 7-3 shows the options for this parameter:

**Table 7-3: Seq Appl Parameter Options**

Options	Value	Meaning
Disabled	0	The Sequencer mode of the X4 is not active and the sequencer parameters are not visible in Level 2 programming.
1 sec base	1	The Sequencer mode of the X4 is active, sequencer parameters are visible in Level 2, and all timing for the sequencer will be on a 1-second base.
.1 sec base	2	The Sequencer mode of the X4 is active, sequencer parameters are visible in Level 2, and all timing for the sequencer will be on a .1-second base.
.01 sec base	3	The Sequencer mode of the X4 is active, sequencer parameters are visible in Level 2, and all timing for the sequencer will be on a .01-second base.

### 7.4.2 Controlling the X4 Program Sequencer

The Program Sequencer can be activated and controlled from either the keypad or the terminal strip. It is not possible to control the sequencer through the serial link. The control method of the program sequencer is determined by parameter **201, Input Mode**. Setting the Input Mode parameter also

allows switching from Sequencer mode to normal keypad operation by way of the Local/Remote switch. Table 7-4 illustrates possible program sequencer control configurations.

**Table 7-4: Program Sequencer Control Configuration**

Input Mode Setting	Input Mode Value	Local Operation	Remote Operation
Local Only	0	Sequencer control via keypad (FWD/ Stop) Default Seq Ref is keypad	N/A
Remote Only	1	N/A	Seq control via FWD terminal Default Seq Ref is "Ref Select"
L/R Rem Ref	2	Normal X4 keypad operation (Sequencer disabled)	Seq control via keypad (FWD/Stop) Default Seq Ref is "Ref Select"
L/R Rem Ctl	3	Normal X4 keypad operation (Sequencer disabled)	Seq control via FWD terminal Default Seq Ref is keypad
L/R Rem Bth	4	Normal X4 keypad operation (Sequencer disabled)	Seq control via FWD terminal Default Seq Ref is "Ref Select"
EMOP	5	Sequencer not enabled	Sequencer not enabled
EMOP2	6	Sequencer not enabled	Sequencer not enabled
LOC/EMOP	7	Sequencer not enabled	Sequencer not enabled
LOC/EMOP2	8	Sequencer not enabled	Sequencer not enabled

*Note: If Input Mode is configured to any of the EMOP options, the sequencer is not available.*

#### **Keypad Control (Activation) of the X4 Program Sequencer**

When activating or controlling the X4 Program Sequencer from the keypad, pressing the FWD key commands the drive to cycle through the programmed states of the sequencer one time only (one-shot operation). One-shot operation will run the sequencer until state 9 is reached, or until any state that is not changed from the default is reached.

Pressing the SHIFT and FWD keys simultaneously causes the programmed sequence to repeat until the Stop key is pressed (continuous operation). In continuous mode, the sequencer runs until state 9 or any state that is not changed from the default is reached; it then jumps back to state 1.

Note that the REV key has no function in the sequencer mode.

#### **Terminal Control of the X4 Program Sequencer**

When activating or controlling the X4 Program Sequencer from terminals, continuous and one-shot operation is determined by whether the drive is wired for 2-wire or 3-wire control. If the terminal is set up for 2-wire control, the sequencer operates in continuous mode (R/J terminal inactive). This will run the sequencer until the Forward command is removed. If the terminal is set up for 3-wire control, the sequencer runs one cycle when the FWD terminal is activated.

Note that the REV terminal has no function in sequencer mode.

**X4 Sequencer Dwell Functionality**

The X4 sequencer has the capability to dwell, or pause, in a state and disregard any command to advance to the next state. This can be done in two different ways, and both methods can be used at the same time.

If the sequencer is actively running and the Enter key is pressed from the Operate screen of the X4 keypad, the sequencer will dwell in the current state (it will never advance to the next state). While the sequencer is dwelling, a warning of "Seq Dwell" will flash on the Operate screen. To leave the dwell state, press the Enter key again from the Operate screen.

The sequencer Dwell mode can also be entered by programming a digital input to "Seq Dwell." The sequencer will then dwell in the current state, for as long as the digital input is active.

**X4 Sequencer Advance Functionality**

The sequencer has the ability to allow the user to advance to the next state without satisfying the conditions programmed to advance. To do this, program a digital input to "Seq Advance." When a digital input program to this option changes from inactive to active, a running sequencer will advance one state. This feature is useful when debugging a sequence with long time intervals.

**7.4.3 Sequencer State Configuration Overview**

Each state of the program sequencer is defined by five characteristics:

- Direction in which the drive will operate
- Speed at which the drive will operate
- Ramp selection of the drive
- Output configuration (relays and digital outputs) of the drive
- How the sequencer advances to the next state.

These five characteristics are configured by two parameters for each state. These parameters are named "Seq Cntl X" and "Seq Count X," where X represents the state number of the sequencer. The "Seq Cntl X" parameter is a binary parameter that sets each of the five characteristics listed above. "Seq Count X" configures the threshold that the sequencer will use in determining when to advance by the method programmed in the control parameter. The bit patterns of the Seq Cntl X" parameters are shown in Figure 7-1:

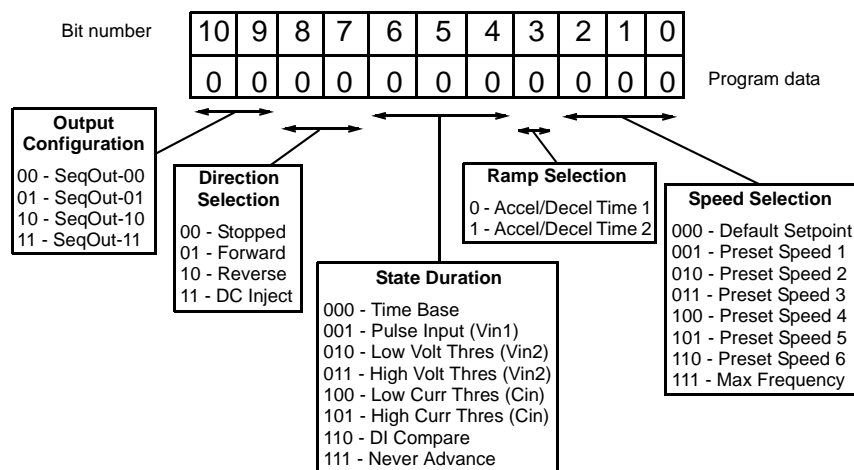

**Figure 7-1: Seq Cntl Parameter, Bit Definition**

**X4 Sequencer Speed Selection**

Table 7-5 gives more information on the speed selection options available in the X4 sequencer by programming bits 0, 1, and 2 of each state's control parameter. The options include any Preset Speed, Max Frequency, or allowing the reference to be determined in the normal X4 control path.

**Table 7-5: Speed Selection Options**

Binary Value	Definition (Resulting Speed)
000	Speed selection as in normal X4 operation, as defined by parameters <b>204</b> (Ref Select) and <b>201</b> (Input Mode).
001	Value of parameter Preset Speed 1( <b>303</b> )
010	Value of parameter Preset Speed 2( <b>304</b> )
011	Value of parameter Preset Speed 3( <b>305</b> )
100	Value of parameter Preset Speed 4( <b>306</b> )
101	Value of parameter Preset Speed 5( <b>307</b> )
110	Value of parameter Preset Speed 6( <b>308</b> )
111	Value of parameter Max Frequency ( <b>302</b> )

**X4 Sequencer Ramping Selection**

When the sequencer is active, the active ramp is no longer determined by parameter "Ramp Select." The user, however, does have the choice of using the main ramps (Accel Time 1/Decel Time1), or the alternate ramps (Accel Time 2/Decel Time 2) for each independent state. This is determined by bit 3 of the control parameter. If bit 3 is set to 1, then the alternate ramps are used (Accel Time 2/Decel Time 2).

**Sequencer Output Configuration**

The X4 Program Sequencer allows digital outputs to be activated during states of the sequencer. This function could be used to activate other devices in a system or to signal to an operator when a part of the sequence is active. The user sets the digital output by setting bits 9 and 10 of the control parameter with a binary value, and then sets a digital output parameter with the option for that same binary value. For example, if a control state was output configured for a binary value of 11, then any digital output configured to "SeqOut-11" would be activated during that time.

**Sequencer Direction Selection**

The sequencer allows each state to be configured as running **Forward**, **Reverse**, **Stopped**, or **DC Injected** by setting bits 7 and 8 of the control parameters.

**Sequencer State Duration**

Bits 4, 5, and 6 of each sequencer control parameter specify how that step will allow advancement to the next step. The options for advancement are **time**, **pulse input**, **voltage threshold**, **current threshold**, or **digital input comparison**. After the advancement method is selected with these bits, the threshold of advancement is determined by the state's count parameter (see the next paragraph).

**Sequencer State Advance Threshold (via Count Parameter)**

The sequencer count parameters work in conjunction with the state duration configuration in the control parameter to determine when to advance to the next state. The function of this parameter is dependent on the state duration configuration as defined in Table 7-6 on page 79. The range of data

programmed into this parameter can be from 0 to 65,535, and can represent time, pulse counts, analog voltage thresholds, analog current thresholds, or digital comparison values.

**Table 7-6: Seq Count Definition Based on Cntl Parameter Configuration**

Bits 4,5,6 of Seq Cntl	Description of Seq Count Function				
000	<b>Time Base</b> - The current sequencer state will last for a time interval equal to the number "Seq Count X" multiplied by the time base configured in the Seq Appl parameter.				
	<b>Seq Appl Setting</b>	<b>Time to Advance</b>	<b>Maximum Sequence Time</b>		
	1 sec Base	(1 sec) * (Seq Count X)	18.2 hours		
	.1 sec Base	(0.1 sec) * (Seq Count X)	1.82 hours		
	0.1 sec Base	(0.01 sec) * (Seq Count X)	10.92 minutes		
001	<b>Pulse Count</b> - The current sequencer state will last until the number of pulses programmed into "Seq Count X" is detected on terminal Vin1.				
010	<b>Low Analog Voltage Threshold</b> - The active sequencer state lasts until the voltage signal applied to terminal Vin2 is < a value programmed into "Seq Count X." The value programmed into "Seq Count X" should be the percentage of input after span and offset are applied (where 100.00% = 10000). <b>Note:</b> The % of analog input after span and offset can be read in parameter <b>912, Vin2 Status</b> .				
011	<b>High Analog Voltage Threshold</b> - The active sequencer state lasts until the voltage signal applied to terminal Vin2 is > a value programmed into "Seq Count X." The value programmed into "Seq Count X" should be the percentage of input after span and offset are applied (where 100.00% = 10000). <b>Note:</b> The % of analog input after span and offset can be read in parameter <b>912, Vin2 Status</b> .				
100	<b>Low Analog Current Threshold</b> - The active sequencer state lasts until the current signal applied to Cin terminals is < a value programmed into "Seq Count X." The value programmed into "Seq Count X" should be the percentage of input after span and offset are applied (where 100.00% = 10000). <b>Note:</b> The % of analog input after span and offset can be read in parameter <b>911, Cin Status</b> .				
101	<b>High Analog Current Threshold</b> - The active sequencer state lasts until the current signal applied to Cin terminals is > a value programmed into "Seq Count X." The value programmed into "Seq Count X" should be the percentage of input after span and offset are applied (where 100.00% = 10000). <b>Note:</b> The % of analog input after span and offset can be read in parameter <b>911, Cin Status</b> .				
110	<b>Digital Comparison</b> - The active sequencer state lasts until the binary value of digital inputs configured to Seq1, Seq2, and Seq3 is equal to the value programmed into "Seq Count X." <b>Note:</b> For this option to work, "Dlx Configure" parameters must be set to "Seq1," "Seq2," and "Seq3."				
	<b>Seq Count</b>	<b>Digital Input Terminals</b>			<b>Description</b>
		<b>Seq1</b>	<b>Seq2</b>	<b>Seq3</b>	
	0	0	0	0	No input active
	1	1	0	0	Seq1 active
	2	0	1	0	Seq2 active
	3	1	1	0	Seq1 & Seq2 active
	4	0	0	1	Seq3 active
5	1	0	1	Seq1 & Seq3 active	
6	0	1	1	Seq2 & Seq3 active	
7	1	1	1	Seq1, Seq2, Seq3 active	
111	The sequencer will never advance if this option is selected.				

### 7.4.4 Sequencer Status Indicators

When the sequencer is enabled, the control path indication field on the keypad will indicate SQ<sub>x</sub>, where *x* represents the active state of the sequencer. A sample operate screen (where the sequencer is in state 1) is shown below:

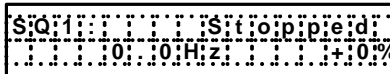

When the sequencer is running, a warning, “Seq Running,” will flash on the screen to indicate that the drive control state may change without user input. For example:

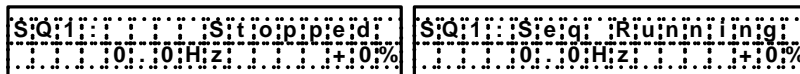

When the sequencer is dwelling (pausing) in a state, a warning, “Seq Dwell,” will flash on the screen to indicate that the sequencer will not advance. For example:

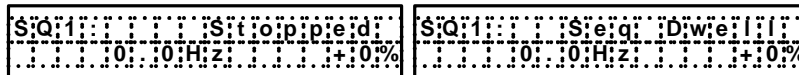

### 7.4.5 Sample Sequencer Program

A machine is required to run in the forward direction at 50 Hz for one hour, then quickly decelerate to a stop. While stopped, a digital output must be enabled to sound an alarm to an operator. After two minutes, the machine must accelerate in the reverse direction to 5 Hz until a limit switch is activated., causing the drive to decelerate to a stop. The following three sequential states can be programmed using only the drive:

**Table 7-7: Sample Sequencer Program Requirements**

	State 1	State 2	State 3
Direction Selection	Forward	Stop	Reverse
Speed Selection	50 Hz	Zero speed	5 Hz
Ramp Selection	Primary	Alternate	Primary
Output Configuration	SeqOut-00	SeqOut-01	SeqOut-10
State Duration	1 hour	2 minutes	Until DI active

First, since two of the sequential states are time-based, the proper setting of the “Seq Appl” parameter must be determined. Since there is not time required that has resolution needed of less than one second, the “1 sec Base” option is the easiest to use. If greater resolution is needed (for example, if a state needed to last for 2.5 seconds), another option should be chosen.

Since the sequence requires use of a digital input and a digital output, two non-sequencer parameters need to be used. Set the parameter “DI1 Configure” to “Seq1” and the parameter “DO1 Configure” to “SeqOut-01.”

Since control of the sequencer is only needed from the keypad, the configuration of the “Input Mode” parameter should be “Local Only.”



Required parameter modifications for this program are provided in Table 7-8, with explanations.

**Table 7-8: Required Parameter Settings for Sample Sequencer Program**

Parameter	Value	Explanation
Seq Appl	"1 sec Base"	Sets 1 second time increments
DI1 Configure	"Seq1"	Allows DI1 to end state 3
DO1 Configure	"SeqOut-01"	Allows DO1 to be active in state 2
Preset Speed 1	5 Hz	Speed for state 3
Preset Speed 6	50 Hz	Speed for state 1
Seq Cntl1	00010000110	No outputs/FWD/Timed/Primary Ramp/Preset Speed 6
Seq Count 1	3600	1 hour = 3600 seconds
Seq Cntl 2	01000001000	Enable Output/Stop/Timed/Alt Ramp/Speed Ignored
Seq Count 2	120	2 minutes = 120 seconds
Seq Cntl 3	00101100001	No outputs/REV/DI Value/Primary Ramp/Preset Speed 1
Seq Count 3	1	Seq1 active

**Worksheet for Sequencer Program Setup**

Step	Output Configuration		Direction Selection		State Duration		Ramp Selection		Speed Selection	
1										
2										
3										
4										
5										
6										
7										
8										
9										
10										

## Chapter 8: Troubleshooting

### 8.1 X4 Fault Codes

Table 8-1 shows the fault codes that may be displayed during X4 AC drive operation, along with suggestions for recovering from the fault condition.

When faults occur, you can access the status parameters that are saved along with the fault (Advanced Fault history). To view these parameters, which store the drive's status at the time of the fault, view **Fault History**, and select **Last Fault**. Press the **Shift** key while viewing the last fault, and then use the **UP** and **DOWN** arrow keys to scroll through the stored drive status parameters. Press the **Shift** key again to return to the programming mode fault parameter.

**Table 8-1: X4 Fault Codes** (Page 1 of 5)

Code	Fault Display	Description	Adv. Fault Code	Explanation	Suggestions for Recovery
1	System	System fault	0,1,2	Internal microprocessor problem	Consult factory for repair or replacement.
			3	Thermistor profile incorrect	Consult factory for repair or replacement.
2	EE Checksum	Checksum error	0	Memory problem when reflashing the drive's memory	<ul style="list-style-type: none"> <li>Reset drive to factory settings.</li> <li>Consult factory.</li> </ul>
			1,2,3	Conflict in drive's memory	<ul style="list-style-type: none"> <li>Reset drive to factory settings.</li> <li>Consult factory.</li> </ul>
			4	Unable to write an EE parameter after a parameter has been changed through the keypad or SIO	<ul style="list-style-type: none"> <li>Reset drive to factory settings.</li> <li>Consult factory.</li> </ul>
			5	The drive is receiving EE write requests faster than they can be processed. This would typically be caused by writing parameters too frequently through Modbus.	Slow down the frequency of Modbus writes.
3	Curr Calibr	Current calibration fault	0	Current calibration fault on phase T1/U	<ul style="list-style-type: none"> <li>Check the motor connections to the terminal strip of the drive and at the motor.</li> <li>Have motor checked.</li> <li>Consult factory for repair or replacement of drive.</li> </ul>
			1	Current calibration fault on phase T2/V	
			2	Current calibration fault on phase T3/W	
4	Power Supp	Power supply fault	0	5V supply is below 4 Vdc for more than 100 ms	<ul style="list-style-type: none"> <li>Increase resistance between REF and analog inputs.</li> <li>Check wiring to REF terminals.</li> <li>Consult factory.</li> </ul>
6	IOC Trip	Instantaneous overcurrent trip	0	Short circuit was detected on power-up	<ul style="list-style-type: none"> <li>Remove the short from the power wiring</li> <li>Check for shorted motor</li> <li>Consult factory.</li> </ul>
			1	Short circuit was detected during operation	
7	MOL	MOL contact fault	0	The MOL digital input was activated, depending on pull-up or pull-down logic configuration	Reset MOL contact or remove condition causing the MOL contact activation.

**Note:** Shaded faults are auto-resettable, except where noted.

Table 8-1: X4 Fault Codes (Page 2 of 5)

Code	Fault Display	Description	Adv. Fault Code	Explanation	Suggestions for Recovery
8	Model ID	ID # out of range	0,1,2	Control board is not reading the drive ID properly	Consult factory for repair or replacement.
10	Res Lockout	Restart lockout	0	The number of fault restarts is greater than the limit defined in the customer parameter.	Check the actual fault in the fault log and use the appropriate remedy.
11	Ground	Ground fault	0	The drive has detected current imbalance between output phases. Imbalance determined to be current flow to ground.	<ul style="list-style-type: none"> <li>• Check for unbalanced currents.</li> <li>• Check for grounded motor leads or motor.</li> <li>• Consult factory.</li> </ul>
12	Vac Imblnce	Input voltage imbalance	0	The drive has detected a single-phase condition or a voltage imbalance outside the drive's rating while running a load that could be damaging to the drive.	Check input voltage and current for imbalance, and correct.
13	OverVoltage	Overvoltage condition	0	<ul style="list-style-type: none"> <li>• The drive has detected an overvoltage condition during power-up (<i>not auto-resettable</i>).</li> </ul>	Verify incoming line power is within specification. Add reactor or transformer to correct.
			1,3	<ul style="list-style-type: none"> <li>• The drive has detected an overvoltage condition during a running condition.</li> </ul>	Verify incoming line power and check for regenerative load. Reduce Regen load or add dynamic braking resistors. Regen Current Limit may help; consult factory.
			2	<ul style="list-style-type: none"> <li>• The drive has detected an overvoltage condition on power-up on the load side.</li> </ul>	Verify incoming line power is within specification. Add reactor or transformer to correct.
15	Dyn Brake	Dynamic brake overload	0	<ul style="list-style-type: none"> <li>• The DB circuit is active on power-up (<i>not auto-resettable</i>)</li> </ul>	Check for failed braking transistor. Consult factory.
			1	<ul style="list-style-type: none"> <li>• The DB circuit is being activated for too long, possibly causing the resistor to overheat or fail.</li> </ul>	Reduce braking cycle or increase capacity. Activate current limit; consult factory.
			2	<ul style="list-style-type: none"> <li>• The DB circuit is overloaded because of too large a regenerative load.</li> </ul>	Reduce braking cycle or increase capacity. Activate current limit; consult factory.
			3,4,5	<ul style="list-style-type: none"> <li>• The DB circuit is faulty on power-up (<i>not auto-resettable</i>).</li> </ul>	
18	OverCurrent	Overcurrent condition	0	<ul style="list-style-type: none"> <li>• The drive sensed an overcurrent condition on power-up (<i>not auto-resettable</i>).</li> </ul>	Check for failed output power device or shorted motor.
			1	<ul style="list-style-type: none"> <li>• The drive sensed an overcurrent condition during operation. The current has exceeded the safe operation point of power devices.</li> </ul>	Reduce load on motor. Verify that Motor FLA is programmed correctly. Check for mechanical binding and shock loading.

**Note:** Shaded faults are auto-resettable, except where noted.

Table 8-1: X4 Fault Codes (Page 3 of 5)

Code	Fault Display	Description	Adv. Fault Code	Explanation	Suggestions for Recovery
19	Over Temp	Over- temperature condition	0	<ul style="list-style-type: none"> <li>The temperature of the heatsink exceeded a temperature limit.</li> </ul>	Check that ambient temperature does not exceed drive's rating. Check for fan operation (assuming drive has fans installed).
			1	<ul style="list-style-type: none"> <li>The temperature of the control board exceeded a temperature limit.</li> </ul>	Check that ambient temperature does not exceed drive's rating. Check for fan operation (assuming drive has fans installed).
			2	<ul style="list-style-type: none"> <li>The drive sensed the heatsink thermistor sensor is faulty or not connected properly.</li> </ul>	Check thermistor connections or replace. Consult factory.
			3	<ul style="list-style-type: none"> <li>The drive sensed the control board thermistor sensor is faulty or not connected properly.</li> </ul>	Check thermistor connections or replace. Consult factory.
20	Motor TOL	Motor timed overload trip	0	The drive detected an overload that exceeds the customer's defined overload setting.	Check load current demand. Verify Motor FLA is programmed to the correct value. Verify TOL characteristic is correct for the application.
21	Low Temp	Low temperature	0	This fault occurs if the temperature of the heatsink falls below -10.0 degrees C.	Verify that ambient temperature is within the drive's specifications; increase the ambient temperature if necessary.
22	Ref Loss	Speed reference loss	0	The drive detected the analog input was configured to fault if the input current went below the level specified by customer parameters.	Check physical connections for reference signal. Check that programming for 4-20 mA signal is correct. Verify that signal to the drive is correct.
23	Brk Wire	Broken wire detection	0	The drive detected that the potentiometer circuit wiring opened and generated a fault.	Check wiring for loss of connection to control terminals. Check that a proper-value potentiometer is installed.
24	Keypad Loss	Keypad loss	0	This fault occurs because of a problem with the keypad or a keypad connection. It occurs if the drive detects that it cannot read any key presses.	Check the connection from keypad to control board. Note that the keypad is not designed for remote mounting.
			1	This fault occurs because of a problem with the keypad, a keypad connection, or the wrong keypad is being used. It occurs if the keypad ID for an X4 cannot be read.	
			2	This fault occurs because of a problem with the keypad or a keypad connection. It occurs if the drive detects that it cannot write to the LCD.	

**Note:** Shaded faults are auto-resettable, except where noted.

Table 8-1: X4 Fault Codes (Page 4 of 5)

Code	Fault Display	Description	Adv. Fault Code	Explanation	Suggestions for Recovery
25	Comm Loss	Communication loss	0	This fault occurs when the drive is in a serial link control path and the amount of time since the last Modbus comm. exceeds the time set in parameter <b>903 (SIO Timer)</b> .	Check connections to the Modbus port. Adjust value of parameter <b>903 (SIO Timer)</b> as needed.
26	Regen Time	Regen timeout	0	This fault occurs if the drive takes more time to decelerate to a stop than is allowed. The timeout is determined by the longest deceleration ramp time (Decel1 or Decel2) plus the Regen Timeout parameter.	Reduce the amount of regenerative energy or increase the Regen timeout parameter.
27	Pwr Bridge	Power bridge fault	0,1,2	The drive detected a failure in the output power devices.	Check for failed input power device.
28	Drive TOL	Drive timed overload	0	The drive sensed an overload that exceeded the drive rating.	Check that load conditions do not exceed the drive's rating (120% for 60 seconds from nameplate current rating for normal duty and 150% or rated current for 60 seconds heavy duty).
29	Stuck Key	Stuck key error	0	This fault occurs if a key press is detected upon power-up. This would occur because of a defective keypad or because someone was holding down a key when powering-up the drive.	Check for stuck keypad and repair or replace. Consult factory.
30	Param Range	Parameter out of range	0	One of the customer parameters is out of range.	Check for a parameter value saved out of the standard range. Reset parameters to factory default. Consult factory.
31	Pwr Wiring	Power wiring error	0	This fault flags a problem with the drive wiring.	Check that input power wiring is not connected to load power terminals. Consult factory.
			1	This fault can occur if an IOC fault is detected during the power wiring test.	
32	Low Voltage	Low voltage trip	0	This fault occurs if a power dip occurs when the drive is operating, and the drive is not able to ride through the power dip before shutting off outputs.	Verify that input line power is within the drive's specifications. Add a transformer or reduce demands to power feed. Consult factory.
33	1Ph Overload	1Ph overload	0	If the user configures parameter <b>517 (Single Phase)</b> for single-phase operation, this fault occurs if the bus voltage ripple is outside the limit of the drive.	Check that input power demand does not exceed the drive's capacity for single-phase operation. Consult factory.
34	RS Meas. Fail	Stator resistance measurement failed	0	If the drive cannot measure the stator resistance properly, this fault occurs.	Try the routine again and if the fault occurs twice, consult the factory.

**Note:** Shaded faults are auto-resettable, except where noted.

**Table 8-1: X4 Fault Codes** (Page 5 of 5)

Code	Fault Display	Description	Adv. Fault Code	Explanation	Suggestions for Recovery
35	Fan Loss	Loss of fan control or operation	0	There is a problem with the heat sink fan.	Consult factory.
			1	There is a problem with the internal fan. This occurs only on Size 4 and 5 models. All other models display a fan error warning.  Note that this is lack of fan control, so the fan can be spinning and this fault will still occur. This can happen if the fan is on and should not be, or if the fan feedback signals are obstructed from getting to the control board.	

**Note:** Shaded faults are auto-resettable, except where noted.

## EU Declaration of Conformity

WE: TB Wood's, Inc.  
440 North Fifth Avenue  
Chambersburg, PA 17201 USA

hereby declare that the products:

**Product Name:** X4 Series  
**Model Number:** X4C1S010C, X4C20010C, X4C20020C, X4C20030C, X4C20050C, X4C20075C,  
X4C20100C, X4C20150C, X4C20200C, X4C20300C, X4C40010C, X4C40020C,  
X4C40030C, X4C40050C, X4C40075C, X4C40100C, X4C40150C, X4C40200C,  
X4C40250C, X4C40300C, X4C40400C, X4C40500C, X4C40600C, X4C40750C,  
X4C41000C, X4C41250C, X4C41500C, X4C42000C, X4C50010C, X4C50020C,  
X4C50030C, X4C50050C, X4C50075C, X4C50100C, X4C50150C, X4C50200C,  
X4C50250C, X4C50300C, X4C50400C, X4C50500C, X4C50600C, X4C50750C,  
X4C51000C, X4C51250C, X4C51500C, X4C52000C

have been designed and manufactured in accordance with standards:

Low Voltage Directive: EN50178  
Electronic equipment for use in power installations  
Electromagnetic compatibility: EN61800-3  
Adjustable speed electrical power drive systems – Part 3:  
EMC product standard including specific test methods

The products referenced above are for the use of control of the speed of AC motors.

The use in residential and commercial premises (Class B) requires an optional WLF series filter.

Via internal mechanisms and Quality Control, it is verified that these products conform to the requirements of the Directive and applicable standards.

Chambersburg, PA, USA — May 31, 2007



Frank H. Custis  
Marketing Manager,  
Electronics Division





## **USA SALES**

### **TB Wood's Incorporated Headquarters**

440 North Fifth Avenue  
Chambersburg, Pennsylvania 17201-1778  
Telephone: 888-TBWOODS or 717-264-7161  
FAX: 717-264-6420  
Website: www.tbwoods.com

## **INTERNATIONAL SALES**

### ***Canada***

**T.B. Wood's Canada Ltd.**  
750 Douro Street  
Stratford, Ontario, Canada N5A 6V6  
Telephone: 519-271-5380  
FAX: 519-271-3094

### ***Germany***

**Berges electronic GmbH**  
Industriestraße 13  
D-51709 Marienheide, Germany  
Telephone: 49-2264-17-0  
FAX: 49-2264-17-126

### ***India***

**TB Wood's (India) Private Limited**  
#27, 'E' II Cross, Electronic City  
Hosur Road  
Bangalore, 560 100 India  
Telephone: 080-30280123  
FAX: 080-30280124

### ***Italy***

**Berges electronic s.r.l.**  
Via Zona Industriale, 11  
I-39025 Naturno, Italy  
Telephone: 39-0473-67-1911  
FAX: 39-0473-67-1909

### ***Mexico***

**Industrial Blaju S.A. de C.V.**  
Oriente 237 No. 171  
Colonia Agricola Oriental  
08500 Mexico, D.F. Mexico  
Telephone: 52-55-55-58-16-20  
FAX: 52-55-57-56-06-74

### **Other TB Wood's Locations**

Chattanooga, Tennessee  
Edmonton, Canada  
Montreal, Canada  
Mt. Pleasant, Michigan  
Reno, Nevada  
San Marcos, Texas  
Scotland, Pennsylvania

***Authorized Distributors Worldwide***

